

INTERRA

ITR411-002 – WALL MOUNT OUTDOOR MICROWAVE SENSOR

Product Manual



Information contained in this publication regarding device applications and the like is provided only for your convenience and may be superseded versions by updates. It is your responsibility to ensure that your application meets with your specifications.

INTERRA MAKES NO REPRESENTATIONS OR WARRANTIES OF ANY KIND WHETHER EXPRESS OR IMPLIED, WRITTEN OR ORAL, STATUTORY OR NONSTATUTORY, RELATED TO THE INFORMATION INCLUDING BUT NOT LIMITED TO ITS CONDITION, QUALITY, PERFORMANCE, MERCHANTABILITY OR FITNESS FOR PURPOSE.

Interra disclaims all liability arising from this information and its use. Use of Interra devices in life support and / or safety applications is entirely at the buyer's risk, and the buyer agrees to defend, indemnify and hold harmless Interra from any and all damages, claims, suits, or expenses resulting from such use. No licenses are conveyed, implicitly or otherwise under any Interra intellectual rights.

Trademarks

The Interra name and logo and the Interra ITR411-002 Wall Mount Outdoor Microwave Sensor are registered trademarks of Interra Technology in Turkey and other countries.

All other trademarks mentioned herein are property of the Interra Technology.

© 2019, Interra, Printed in Turkey, All Rights Reserved.



Printed on recycled paper.

TS EN ISO 9001:2008

TO OUR CUSTOMERS

One of our most important aims is to provide you with the best documentation possible to use successfully your Interra products. Focusing of this, we will keep on improving our documentation to better suit your needs. Our publications will be updated as new volumes as soon as changes are introduced.

If you have any questions or comments regarding this publication, do not hesitate to contact us:

E-mail: info@interra.com.tr

Tel: +90 (216) 326 26 40 Fax: +90 (216) 324 25 03

Most Current Product Manual

To obtain the most up-to-date version of this product manual, please visit our Web site at:

<http://www.interra.com.tr>

You can determine the version of an Interra document examining its literature number found on the bottom right corner of any page.

The first two letters of the literature are the type of document. The numbers that follow are the creation date of the document and the last letter is the version (e.g., PM181017001A is the version A of a product manual created on the date 17/10/18.)

CONTENTS

1.) PRODUCT DESCRIPTION.....	6
1.1.) TECHNICAL INFORMATION	7
1.2.) PRODUCT FUNCTIONS.....	8
1.3.) PRODUCT DIMENSIONS	9
1.4.) CONNECTION DIAGRAM AND PROGRAMMING.....	9
1.5.) MICROWAVE SENSING RANGES	10
3.1. GENERAL PARAMETER PAGE.....	11
3.1.1. Parameters List	12
3.2. CONSTANT BRIGHTNESS A & B PARAMETER PAGE	16
3.2.1. Parameters List	17
3.3. FORCED OPERATION.....	19
3.3.1. Parameters List	20
3.4. TRIGGER	22
3.4.1. Parameters List	22
3.5. FUNCTION STATUS.....	24
3.5.1. Parameters List	25
3.6. DRY CONTACT FUNCTION	27
3.6.1. Parameters List	28
3.7. LOGIC FUNCTION	31
3.7.1. Parameters List	32
3.8. BLOCK A.....	38
3.8.1. Parameters List	39
3.9. A1:SWITCHING.....	39
3.9.1. Parameters List	40
3.10. A1:DIMMING	41
3.10.1. Parameters List	41
3.11. A1:SHUTTER	42
3.11.1. Parameters List	43
3.12. A1:ALARM	44
3.12.1. Parameters List	44
3.13. A1:PERCENTAGE.....	45
3.13.1. Parameters List	46
3.14. A1:SEQUENCE.....	47
3.14.1. Parameters List	47

3.15. A1:SCENE.....	48
3.15.1. Parameters List.....	49
3.16. A1:STRING.....	50
3.16.1. Parameters List.....	50
3.17. A1:THRESHOLD.....	52
3.17.1. Parameters List.....	52
4.1. GENERAL.....	54
4.2. FUNCTION STATUS.....	54
4.3. LUX THRESHOLD.....	55
4.4. TEMPERATURE THRESHOLD.....	55
4.5. HUMIDITY THRESHOLD.....	55
4.6. EXTERNAL TELEGRAM.....	56
4.7. OBJECT OUTPUT.....	56
4.8. OBJECT INPUT.....	57
4.9. LOGIC A.....	59
4.10. EXTEND CONTACT.....	59
4.11. CONSTANT BRIGHTNESS A.....	60
4.12. FORCED OPERATION.....	61
4.13. FORCED OPERATION DIMMING.....	61
4.14. CONSTANT BRIGHTNESS A TRIGGER.....	62

1.) PRODUCT DESCRIPTION

ITR411-002 – Wall Mount Outdoor Microwave Sensor is used to operate building functions. Database uploads to the product are done with ETS software's current versions. The device is manufactured in accordance with electromagnetic compatibility (EMC), electrical safety and environmental conditions. ITR411-002 includes 4 independent logic blocks and 1 combined logic block, the logic relation can be "AND" "OR", logic input conditions can be the condition of LUX sensor, microwave sensor, temperature sensor, dry contact, external telegram.

1.1.) TECHNICAL INFORMATION

Device	ITR411-002
Power Supply	EIB Power Supply
Current Consumption	20 mA (static) 24 mA (dynamic)
Illumination Detection Range	0 ~ 15000 LUX
Temperature Detection Range	-30°C ~ 70°C
Maximum Air Humidity	<90 RH
Temperature Range	Operation (- 5°C ...45 °C) Storage (- 20°C ...60 °C)
Flammability	Non-flammable Product
Type of Protection	IP 56
Dimensions	126 x 78 x 114 mm (HxWxD)
Color	Light Grey and White
Configuration	Configuration with ETS
Certificaton	KNX Certified

1.2.) PRODUCT FUNCTIONS

- Built-in LUX sensor, microwave sensor, temperature sensor, dry contact, external telegram.
- The multi-function motion sensor have 5 logic function blocks and can be set the logical relation AND/OR, Each with 10 output objects. The work mode include single mode and Master & Slave mode.
- The multi-function motion sensor can report movement status, Lux status to KNX system.
- The multi-function motion sensor supports constant brightness output.
- It can controls for Switch control, Absolute dimming control, Shutter control, Alarm control, Percentage control, Sequence control, Scene control, String (14 bytes) control, Threshold control, Logic combination control.
- With function of constant brightness: keep the Lux in the constant value, will dim the lights to the corresponding intensity according to the surrounding brightness.
- The logic validity can be set by external telegram, enable end user to enable or disable the preset logics.

1.3.) PRODUCT DIMENSIONS

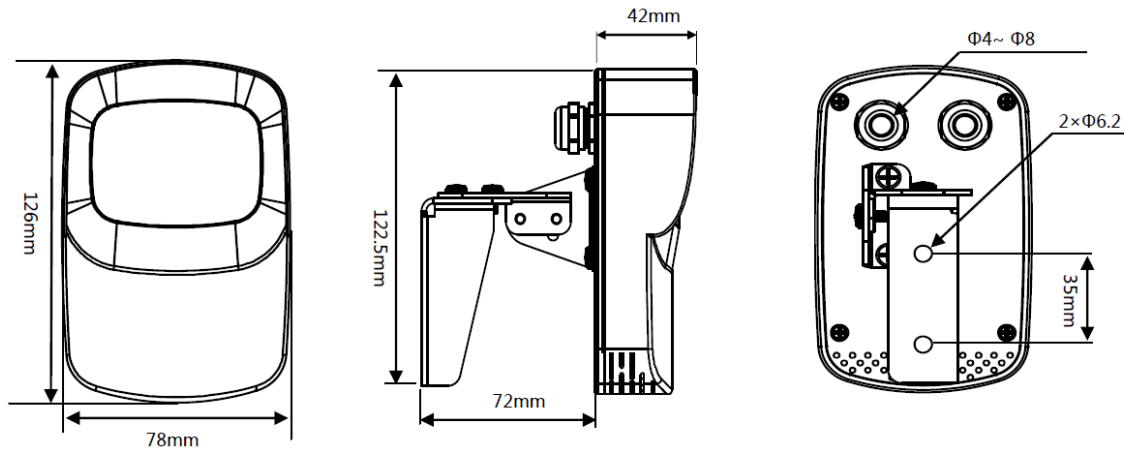

Fig 1 : Front, Side and Rear Appearances and Measures of the Device.

The numerical values showing the dimensions above are in mm.

1.4.) CONNECTION DIAGRAM AND PROGRAMMING

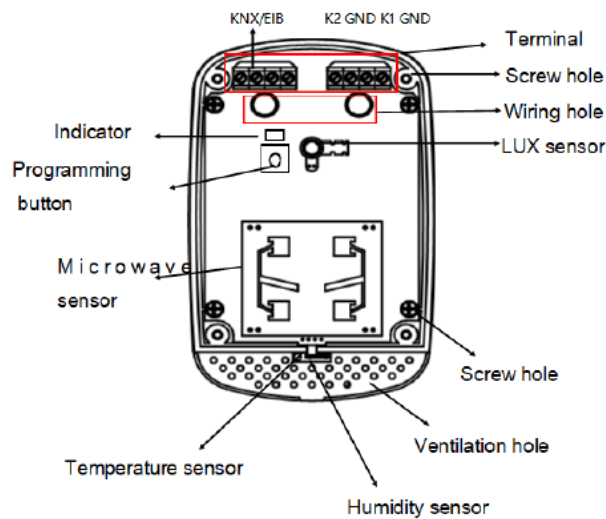

Fig 2 : KNX Connector, Programming LED and Button.

Connection to the device is via the KNX connector and dry contacts. Once the connections have been made correctly, the device can now be programmed. The programming button is pressed first, then the programming LED is illuminated after pressing. In this way, the ETS configuration can be loaded to the device.

1.5.) MICROWAVE SENSING RANGES

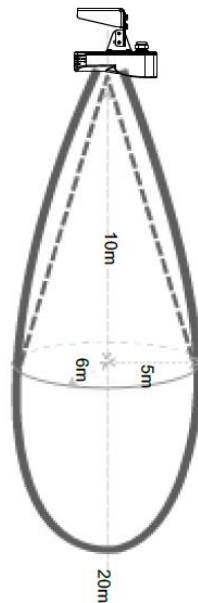

Fig 3 : Microwave Sensor Detection Diagram.

The above figure shows the detection distances of the ITR411-002 Wall Mount Outdoor Microwave Sensor according to the height at which it is installed. The position and height where the sensor is to be placed are important in this respect.

2.) MOUNTING

The installation steps of the ITR411-002 Wall Mount Outdoor Microwave Sensor are described below.

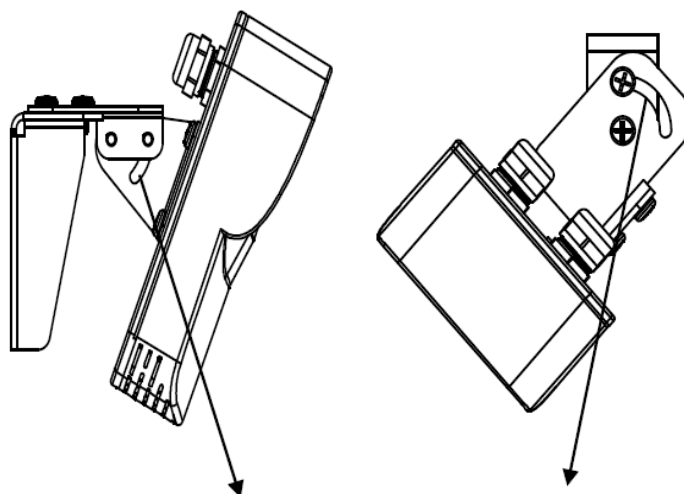

Fig 4 : Device Mounting Scheme

The sensor can be mounted with screws to thick walls, wooden ceiling or special boxes. Fig. 4 shows two different adjustment ranges. It is possible to adjust by $\pm 25^\circ$ on the left side and $\pm 45^\circ$ on the right. Ensure that the bus cable is correctly connected before installing the bracket with the screw. The device must be installed in a location where the contacts are not affected by hazardous liquids and corrosive gases, and the screwing torque value should be less than 0.4Nm. Make sure that no AC voltage is connected to the bus cable after the assembly is complete.

3. ETS PARAMETERS AND OBJECTS

3.1. GENERAL PARAMETER PAGE

When the ITR411-002 device from the ETS program is added to the project, a configuration must be made before the installation. Entering the "General" section of the parameter page opens the following window. The relevant parameters can be set here.

General	System delay(2..255s) after bus voltage recovery	10
Function status	Heartbeat telegram	Disable
Constant brightness A	LED indicator	ON when movement detected
Logic function A	Sensor setting:	
Block A	(1)Microwave sensor sensitivity (1%-100%)	80%
A1: Switching	->Microwave sensor sensitivity via bus	<input checked="" type="radio"/> Disable <input type="radio"/> Enable
Logic function B	(2)Brightness quiver (5..30%)	5%
Logic function C	-> Lux compensation (-500Lux..+500Lux)	0
Logic function D	(3)Temperature hysteresis (0.1°C)	10
Logic function E	-> Temperature compensation (0.1°C)	0
	(4)Humidity hysteresis (1..10%)	1
	->Humidity compensation (-10 %..+10 %)	0
	(5)Dry contact 1 for logic	Disable
	(6)Dry contact 2 for logic	Disable
	Extend dry contact function	<input checked="" type="radio"/> Disable <input type="radio"/> Enable
	Constant brightness:	
	Constant brightness function A	<input type="radio"/> Disable <input checked="" type="radio"/> Enable
	Constant brightness function B	<input checked="" type="radio"/> Disable <input type="radio"/> Enable

Fig 5 : General Parameter Configuration Page

3.1.1. Parameters List

PARAMETERS	DESCRIPTION	VALUES
System delay(2..255s) after bus voltage recovery	This parameter, is used for set the delay time for the device after power on.	2..10..255
Heartbeat telegram	This parameter, is used to send cyclically heartbeat telegrams. If the value is 0, the device will send 0 cyclically. Also, if the value is 0/1, the device will send alternately 0 and 1 value cyclically.	Disable Send value 0 cyclically Send value 1 cyclically Send value 0/1 inverted cyclically
Telegram is sent time interval (1..65535s)*¹	This parameter, allows sending the telegram cyclically after time out.	1..5..65535s
LED indicator	This parameter, is used to configure the LED indicator.	Always is OFF ON when movement detected ON when received 1, else OFF ON when received 0, else OFF ON when logic A is disable, else OFF ON when logic A is enable, else OFF ON when logic B is disable, else OFF ON when logic B is enable, else OFF ON when logic C is disable, else OFF ON when logic C is enable, else OFF ON when logic D is disable, else OFF ON when logic D is enable, else OFF ON when logic E is disable, else OFF ON when logic E is enable, else OFF
(1)Microwave sensor sensitivity (1%-100%)	This parameter, is used to set the microwave sensor sensitivity.	1%...80%...100%

-> Microwave sensor sensitivity via bus	This parameter, is used to enable or disable the microwave sensor sensitivity via bus.	Disabled Enabled
(2) Brightness quiver (5...30%)	This parameter, is used to set the brightness quiver.	5%, 10%, 15%, 20%, 25%, 30%
-> Lux compensation (-500Lux...+500Lux)	This parameter, is used to compensate the Lux value.	-500...0...+500
(3) Temperature hysteresis 0.1°C	This parameter, is used to set the temperature hysteresis.	1..10...50
-> Temperature compensation 0.1°C	This parameter, is used to compensate the temperature value.	-100...0...100
(4) Humidity hysteresis (1...10%)	This parameter, is used to set the humidity hysteresis.	1...10
-> Humidity compensation (-10%...+10%)	This parameter, is used to compensate the humidity value.	-10...0...10
(5) Dry contact 1 for logic	This parameter, is used to set dry contact 1 for logic operations.	Disable Mechanical Switch Electronic Switch
-> Status when closing the contact*2	This parameter, is used to set the status when closing the contact. Unchanged : When closing the contact, the status will be unchanged. Toggle : When closing the contact, the status will be toggle between true and false. Constant to True('1') : When closing the contact, the status will be constant to true. Constant to False('0') : When closing the contact, the status will be constant to false.	Unchanged Toggle Constant to True ('1') Constant to False ('0')
-> Status when opening the contact*2	This parameter, is used to set the status when opening the contact. Unchanged : When opening the contact, the status will be unchanged. Toggle : When opening the contact, the status will be toggle between true and false. Constant to True('1') : When opening the contact, the status will be constant to true. Constant to False('0') : When opening the contact, the status will be constant to false.	Unchanged Toggle Constant to True ('1') Constant to False ('0')

<p>-> Button value when voltage recovery*3</p>	<p>This parameter, is used to set button value when voltage recovery occurs.</p>	<p>Last value Value is True ('1') Value is True ('0')</p>
<p>-> Status when short button operation*3</p>	<p>This parameter, is used to set the status when short button operation occurs.</p> <p>Unchanged : When short press the button, the status will be unchanged.</p> <p>Toggle : When short press the button, the status will be toggle between true and false.</p> <p>Constant to True('1') : When short press the button, the status will be constant to true.</p> <p>Constant to False('0') : When short press the button, the status will be constant to false.</p>	<p>Invalid</p> <p>Toggle Constant to True ('1') Constant to False ('0')</p>
<p>-> Status when long button operation*3</p>	<p>This parameter, is used to set the status when long button operation occurs.</p> <p>Unchanged : When long press the button, the status will be unchanged.</p> <p>Toggle : When long press the button, the status will be toggle between true and false.</p> <p>Constant to True('1') : When long press the button, the status will be constant to true.</p> <p>Constant to False('0') : When long press the button, the status will be constant to false.</p>	<p>Invalid</p> <p>Toggle Constant to True ('1') Constant to False ('0')</p>
<p>-->> Long button time after 0.1s (0.2s~20S) operation*3</p>	<p>This parameter, is used to set long button time after 0.1s.</p>	<p>0.2...10...20</p>
<p>(6) Dry contact 2 for logic</p>	<p>This parameter, is used to set dry contact 2 for logic operations.</p>	<p>Disable Mechanical Switch Electronic Switch</p>
<p>-> Status when closing the contact*4</p>	<p>This parameter, is used to set the status when closing the contact.</p> <p>Unchanged : When closing the contact, the status will be unchanged.</p> <p>Toggle : When closing the contact, the status will be toggle between true and false.</p> <p>Constant to True('1') : When closing the contact, the status will be constant to true.</p> <p>Constant to False('0') : When closing the contact, the status will be constant to false.</p>	<p>Unchanged Toggle Constant to True ('1') Constant to False ('0')</p>

<p>-> Status when opening the contact*⁴</p>	<p>This parameter, is used to set the status when opening the contact.</p> <p>Unchanged : When opening the contact, the status will be unchanged.</p> <p>Toggle : When opening the contact, the status will be toggle between true and false.</p> <p>Constant to True('1') : When opening the contact, the status will be constant to true.</p> <p>Constant to False('0') : When opening the contact, the status will be constant to false.</p>	<p>Unchanged</p> <p>Toggle</p> <p>Constant to True ('1')</p> <p>Constant to False ('0')</p>
<p>-> Button value when voltage recovery*⁵</p>	<p>This parameter, is used to set button value when voltage recovery occurs.</p>	<p>Last value</p> <p>Value is True ('1')</p> <p>Value is True ('0')</p>
<p>-> Status when short button operation*⁵</p>	<p>This parameter, is used to set the status when short button operation occurs.</p> <p>Unchanged : When short press the button, the status will be unchanged.</p> <p>Toggle : When short press the button, the status will be toggle between true and false.</p> <p>Constant to True('1') : When short press the button, the status will be constant to true.</p> <p>Constant to False('0') : When short press the button, the status will be constant to false.</p>	<p>Invalid</p> <p>Toggle</p> <p>Constant to True ('1')</p> <p>Constant to False ('0')</p>
<p>-> Status when long button operation*⁵</p>	<p>This parameter, is used to set the status when long button operation occurs.</p> <p>Unchanged : When long press the button, the status will be unchanged.</p> <p>Toggle : When long press the button, the status will be toggle between true and false.</p> <p>Constant to True('1') : When long press the button, the status will be constant to true.</p> <p>Constant to False('0') : When long press the button, the status will be constant to false.</p>	<p>Invalid</p> <p>Toggle</p> <p>Constant to True ('1')</p> <p>Constant to False ('0')</p>
<p>-->> Long button time after 0.1s (0.2s~20S) operation*⁵</p>	<p>This parameter, is used to set long button time after 0.1s.</p>	<p>0.2...10...20</p>
<p>Extend dry contact function</p>	<p>This parameter, is used to enable or disable the microwave sensor's extended dry contacts.</p>	<p>Disabled</p> <p>Enabled</p>
<p>Constant brightness function A</p>	<p>This parameter, is used to enable or disable the constant brightness function A.</p>	<p>Disabled</p> <p>Enabled</p>

Constant brightness function B	This parameter, is used to enable or disable the constant brightness function B.	Disabled Enabled
---------------------------------------	--	----------------------------

- *1 This parameter, is only visible when the parameter "Heartbeat telegram" is not set to "Disable".
- *2 This parameter, is only visible when the parameter "(5) Dry contact 1 for logic" is set to "Mechanical switch".
- *3 This parameter, is only visible when the parameter "(5) Dry contact 1 for logic" is set to "Electronic switch".
- *4 This parameter, is only visible when the parameter "(6) Dry contact 2 for logic" is set to "Mechanical switch".
- *5 This parameter, is only visible when the parameter "(6) Dry contact 2 for logic" is set to "Electronic switch".

3.2. CONSTANT BRIGHTNESS A & B PARAMETER PAGE

This parameter page allows you to make settings to operate the device at a constant brightness. Various configurations can be defined for the dimming processes and different configurations can be made with external telegrams. Constant brightness A and B parameter pages are identical, so only one is described below. The following window opens when enabling the Constant brightness A parameter page. The "Constant brightness B" parameter page also has the same settings.

The screenshot shows a configuration interface for the Constant Brightness parameter. It features a sidebar menu on the left with options like General, Function status, Dry contact function, Constant brightness A, Constant brightness B, Logic function A, Block A, A1: Switching, Logic function B, Logic function C, Logic function D, and Logic function E. The main area contains the following settings:

- Lux value from:** Radio buttons for Local lux sensor (selected) and External lux telegram.
- > Constant brightness value(0~15K lux):** A numeric input field set to 100.
- Change constant brightness value via bus:** Radio buttons for Disable (selected) and Enable.
- Lux quiver(n%): constant brightness lux*((1-n%) and (1+n%)):** A dropdown menu set to 10%.
- Output setting:**
 - Minimum dimming time interval limit(0.1~5.0 s):** 1.0 s
 - Minimum dimming step value limit(1~10%):** 1%
 - Maximum dimming step value limit(1~10%):** 5%
 - Minimum dimming value limit:** 0%
 - Maximum dimming value limit:** 100%
 - First dimming value of constant brightness after power on:** 80%
- Operational setting:**
 - Constant brightness control after power on:** Start
 - Constant brightness control start/stop via bus:** Disable
 - Output dimming value after constant brightness control stoped:** Unchanged
 - Forced operation:** Radio buttons for Disable (selected) and Enable.
 - Trigger:** Radio buttons for Disable (selected) and Enable.
- PI: $u(k) = K_p(\text{Proportional coefficient})[e(k) - e(k-1)] + K_i(\text{integration time})e(k)$**
- Dimming speed (for PI):** Middle(Ki=15%,Kp=15%)

Fig 5 : Constant Brightness Parameter Page

3.2.1. Parameters List

PARAMETERS	DESCRIPTION	VALUES
LUX value from	This parameter, is used for set the lux value. Local lux sensor: The lux value is depend on the local lux sensor. External lux telegram: The lux value is depend on the external lux telegram.	Local lux sensor External lux telegram
-> Constant brightness value (0-15K lux)	This parameter, is used to set the constant brightness value.	0... 100 ...15000
Change constant brightness value via bus	This parameter, is used to enable or disable the constant brightness value.	Enable Disable
Lux quiver(n%): constant brightness lux (1-n%) and (1+n%)	This parameter, is used to set the lux quiver.	5% 10% 15% 20% 25% 30%
Minimum dimming time interval limit (0.1~5.0s)	This parameter, is used for dimming according to the specified range level.	0.1... 1 ...5.0s
Minimum dimming step value limit (1~10%)	This parameter, is used to set the minimum dimming step value limit.	1 ...10
Maximum dimming step value limit (1~10%)	This parameter, is used to set the maximum dimming step value limit.	1... 5 ...10
Minimum dimming value limit	This parameter, is used to set the minimum dimming value.	0 ...100%
Maximum dimming value limit	This parameter, is used to set the maximum dimming value.	0... 100%
First dimming value of constant brightness after power on	This parameter, is used to set the first dimming value for constant brightness when power on.	0... 80 ...100 Last dimming value
Constant brightness control after power on	This parameter, is used to set the parameter for constant brightness control when power on.	Stop Start Recovery

<p>Constant brightness control start/stop via bus</p>	<p>This parameter, is used to set the constant brightness control.</p> <p>Enable('1'-Start/'0'-Stop): If receive the telegram value '1', the constant brightness will be started, if receive the telegram value '0', the constant brightness will be stopped.</p> <p>Enable('1'-Stop/'0'-Start): If receive the telegram value '0', the constant brightness will be started, if receive the telegram value '1', the constant brightness will be stopped.</p> <p>Disable: Constant brightness control will be disabled.</p>	<p>Enable('1'-Start/'0'-Stop) Enable('1'-Start/'0'-Stop) Disable</p>
<p>Output dimming value after constant brightness control stopped</p>	<p>This parameter, is used to set the output dimming value when constant brightness control stopped.</p>	<p>Unchanged 0...100%</p>
<p>Forced operation</p>	<p>This parameter, is used to enable or disable the forced operation.</p>	<p>Enable Disable</p>
<p>Trigger</p>	<p>This parameter, is used to enable or disable the trigger operation.</p>	<p>Enable Disable</p>
<p>Dimming speed (for PI)</p>	<p>This parameter, is used to set the dimming speed (for PI control).</p>	<p>Defined Lowest(Ki=1%,Kp=1%) Lower(Ki=5%,Kp=5%) Low(Ki=10%, Kp=10%) Middle(Ki=15%,Kp=15%) Fast(Ki=30%,Kp=30%) Faster(Kp=60%,Ki=60%) Fastest(Kp=100%,Ki=100%)</p>
<p>-> Constant brightness Kp (for PI)*¹</p>	<p>This parameter, is used to set Kp controller value for constant brightness control.</p>	<p>1...15...100%</p>
<p>-> Constant brightness Ki (for PI)*¹</p>	<p>This parameter, is used to set Ki controller value for constant brightness control.</p>	<p>1...15...100%</p>

*¹ This parameter, is only visible when the parameter "Dimming speed (for PI)" is set to "Defined".

3.3. FORCED OPERATION

This parameter setting page opens when the parameter "forced operation" is selected as "Enable" on the constant brightness parameter page (for A or B constant brightness). From this section, up to 4 different forced operation parameters can be defined. As at the A and B constant brightness parameter pages, the parameter pages "A: Forced operation" and "B: Forced operation" are identical. For this reason, only one of them is sufficient to explain. The following window is opened when "Forced operation" is activated from the constant brightness parameter page.

General	The forced operation status after power on	To forced operation A1
Function status	Forced operation A1	<input type="radio"/> Disable <input checked="" type="radio"/> Enable
Constant brightness A	-> Forced operation start/stop(stop:back to constant brightness output)	'1'/0'-Start
A: Forced operation	-> Forced operation dimming value	0%
A: Trigger	-> Change forced dimming value via bus	<input checked="" type="radio"/> Disable <input type="radio"/> Enable
Constant brightness B	Forced operation A2	<input type="radio"/> Disable <input checked="" type="radio"/> Enable
B: Forced operation	-> Forced operation start/stop(stop:back to constant brightness output)	'1'-Start,'0'-Stop
B: Trigger	-> Forced operation dimming value	100%
Logic function A	-> Change forced dimming value via bus	<input checked="" type="radio"/> Disable <input type="radio"/> Enable
Block A	Forced operation A3	<input type="radio"/> Disable <input checked="" type="radio"/> Enable
A1: Switching	-> Forced operation start/stop(stop:back to constant brightness output)	'1'-Start,'0'-Stop
Logic function B	-> Forced operation dimming value	80%
Logic function C	-> Change forced dimming value via bus	<input checked="" type="radio"/> Disable <input type="radio"/> Enable
Logic function D	Forced operation A4	<input checked="" type="radio"/> Disable <input type="radio"/> Enable
Logic function E		

Fig 6 : Forced Operation Parameter Page

3.3.1. Parameters List

PARAMETERS	DESCRIPTION	VALUES
The forced operation status after power on	This parameter, is used to set the forced operation status when after power on.	No operation Last forced operation To forced operation A1 To forced operation A2 To forced operation A3 To forced operation A4
-> Forced operation start/stop (stop: back to constant brightness output) *1	This parameter, is used to set for forced operation. '1'-Start, '0'-Stop: If receive telegram value 1 will start, if receive telegram value 0 will stop and back to constant brightness output. '0'-Start, '1'-Stop: If receive telegram value 0 will start, if receive telegram value 1 will stop and back to constant brightness output. '1/0'-Start: If receive telegram value 1 or 0 will start. '1/0'-Stop: If receive telegram value 1 or 0 will stop and back to constant brightness output.	'1'-Start, '0'-Stop '0'-Start, '1'-Stop '1/0'-Start '1/0'-Stop
-> Forced operation dimming value*1	This parameter, is used to set the dimming value for forced operation.	0...100%
-> Change forced dimming value via bus*1	This parameter, is used to enable or disable for changing forced dimming value via bus.	Enable Disable
Forced operation A2*1	This parameter, is used to enable or disable for forced operation A2.	Enable Disable
-> Forced operation start/stop (stop: back to constant brightness output)*2	This parameter, is used to set for forced operation. '1'-Start, '0'-Stop: If receive telegram value 1 will start, if receive telegram value 0 will stop and back to constant brightness output. '0'-Start, '1'-Stop: If receive telegram value 0 will start, if receive telegram value 1 will stop and back to constant brightness output. '1/0'-Start: If receive telegram value 1 or 0 will start. '1/0'-Stop: If receive telegram value 1 or 0 will stop and back to constant brightness output.	'1'-Start, '0'-Stop '0'-Start, '1'-Stop '1/0'-Start '1/0'-Stop
-> Forced operation dimming value*2	This parameter, is used to set the dimming value for forced operation.	0...100%
-> Change forced dimming value via bus*2	This parameter, is used to enable or disable for changing forced dimming value via bus.	Enable Disable

Forced operation A3*2	This parameter, is used to enable or disable for forced operation A3.	Enable Disable
-> Forced operation start/stop (stop: back to constant brightness output)*3	This parameter, is used to set for forced operation. '1'-Start, '0'-Stop: If receive telegram value 1 will start, if receive telegram value 0 will stop and back to constant brightness output. '0'-Start, '1'-Stop: If receive telegram value 0 will start, if receive telegram value 1 will stop and back to constant brightness output. '1/0'-Start: If receive telegram value 1 or 0 will start. '1/0'-Stop: If receive telegram value 1 or 0 will stop and back to constant brightness output.	'1'-Start, '0'-Stop '0'-Start, '1'-Stop '1/0'-Start '1/0'-Stop
-> Forced operation dimming value*3	This parameter, is used to set the dimming value for forced operation.	0...80...100%
-> Change forced dimming value via bus*3	This parameter, is used to enable or disable for changing forced dimming value via bus.	Enable Disable
Forced operation A4*3	This parameter, is used to enable or disable for forced operation A4.	Enable Disable
-> Forced operation start/stop (stop: back to constant brightness output)*4	This parameter, is used to set for forced operation. '1'-Start, '0'-Stop: If receive telegram value 1 will start, if receive telegram value 0 will stop and back to constant brightness output. '0'-Start, '1'-Stop: If receive telegram value 0 will start, if receive telegram value 1 will stop and back to constant brightness output. '1/0'-Start: If receive telegram value 1 or 0 will start. '1/0'-Stop: If receive telegram value 1 or 0 will stop and back to constant brightness output.	'1'-Start, '0'-Stop '0'-Start, '1'-Stop '1/0'-Start '1/0'-Stop
-> Forced operation dimming value*4	This parameter, is used to set the dimming value for forced operation.	0...50...100%
-> Change forced dimming value via bus*4	This parameter, is used to enable or disable for changing forced dimming value via bus.	Enable Disable

*1 This parameter, is only visible when the parameter "Forced operation A1" is set to "Enable".

*2 This parameter, is only visible when the parameter "Forced operation A2" is set to "Enable".

*3 This parameter, is only visible when the parameter "Forced operation A3" is set to "Enable".

*4 This parameter, is only visible when the parameter "Forced operation A4" is set to "Enable".

3.4. TRIGGER

This parameter setting page opens when the parameter "Trigger" is selected as "Enable" on the constant brightness parameter page (for A or B constant brightness). From this section, up to 3 different trigger operation parameters can be defined. As at the A and B constant brightness parameter pages, the parameter pages "A: Trigger" and "B: Trigger" are identical. For this reason, only one of them is sufficient to explain. The following window is opened when "Trigger" is activated from the constant brightness parameter page.

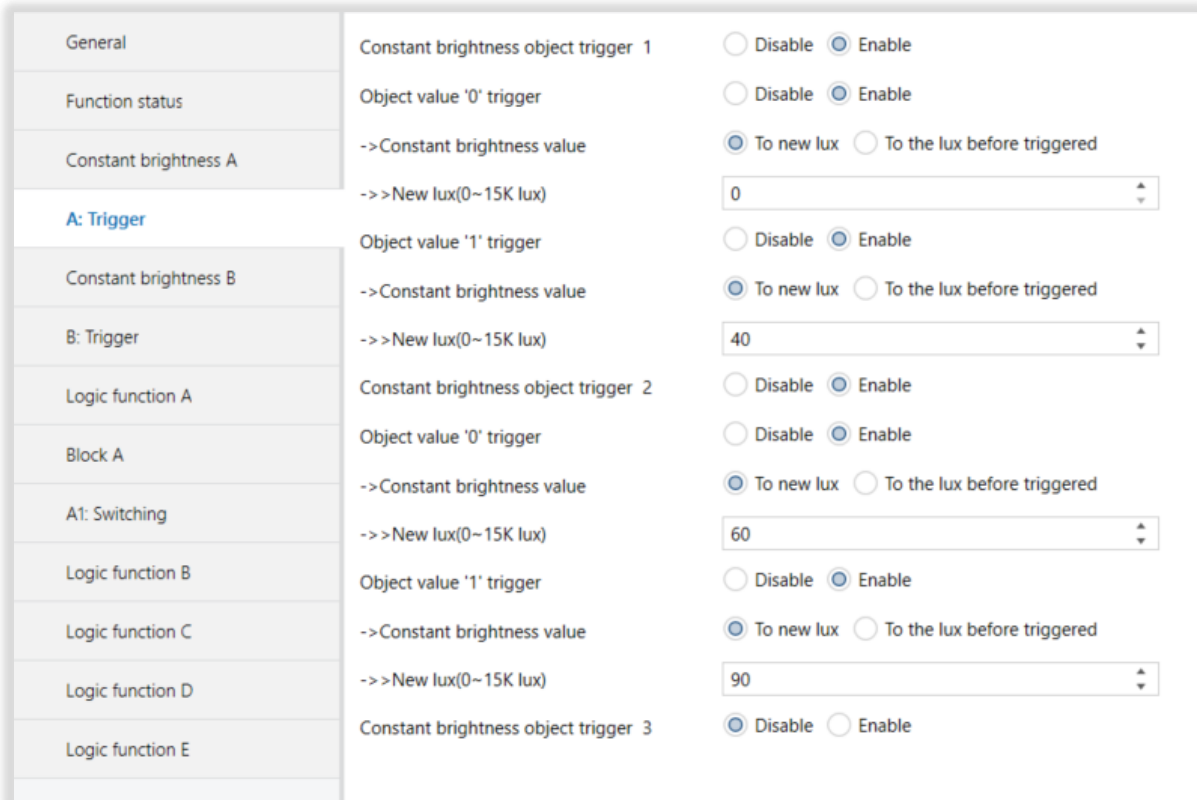

Fig 7 : Trigger Parameter Page

3.4.1. Parameters List

PARAMETERS	DESCRIPTION	VALUES
Constant brightness object trigger 1	This parameter, is used to enable or disable for constant brightness object trigger 1.	Enable Disable
Object value '0' trigger*1	This parameter, is used to enable or disable object value '0' trigger.	Enable Disable
-> Constant brightness value	This parameter, is used to set the constant brightness value.	To new lux To the lux before triggered

->> New lux (0~15K lux)	This parameter, is used to set a new lux value.	0...15000
Object value '1' trigger*1	This parameter, is used to enable or disable the "Object value '1' trigger" parameter.	Enable Disable
-> Constant brightness value	This parameter, is used to set the constant brightness value.	To new lux To the lux before triggered
->> New lux (0~15K lux)	This parameter, is used to set a new lux value.	0... 40 ...15000
Constant brightness object trigger 2	This parameter, is used to enable or disable for constant brightness object trigger 2.	Enable Disable
Object value '0' trigger*2	This parameter, is used to enable or disable object value '0' trigger.	Enable Disable
-> Constant brightness value	This parameter, is used to set the constant brightness value.	To new lux To the lux before triggered
->> New lux (0~15K lux)	This parameter, is used to set a new lux value.	0... 60 ...15000
Object value '1' trigger*2	This parameter, is used to enable or disable the "Object value '1' trigger" parameter.	Enable Disable
-> Constant brightness value	This parameter, is used to set the constant brightness value.	To new lux To the lux before triggered
->> New lux (0~15K lux)	This parameter, is used to set a new lux value.	0... 90 ...15000
Constant brightness object trigger 3	This parameter, is used to enable or disable for constant brightness object trigger 3.	Enable Disable
Object value '0' trigger*3	This parameter, is used to enable or disable object value '0' trigger.	Enable Disable
-> Constant brightness value	This parameter, is used to set the constant brightness value.	To new lux To the lux before triggered
->> New lux (0~15K lux)	This parameter, is used to set a new lux value.	0... 120 ...15000
Object value '1' trigger*3	This parameter, is used to enable or disable the "Object value '1' trigger" parameter.	Enable Disable
-> Constant brightness value	This parameter, is used to set the constant brightness value.	To new lux To the lux before triggered
->> New lux (0~15K lux)	This parameter, is used to set a new lux value.	0... 150 ...15000

*1 This parameter, is only visible when the parameter "Constant brightness object trigger 1" is set to "Enable".

*2 This parameter, is only visible when the parameter “Constant brightness object trigger 2” is set to “Enable”.

*3 This parameter, is only visible when the parameter “Constant brightness object trigger 3” is set to “Enable”.

3.5. FUNCTION STATUS

The temperature, brightness and humidity values can be reported in the event of any change or the periodically determined configuration via the parameter page for the function states. In addition, the status reporting for the dry contact inputs can also be made according to the specified configuration. The following window is opened when entered to the “Function status” parameter page.

General	(1)Slave microwave sensor status report	<input checked="" type="radio"/> No <input type="radio"/> Yes
Function status	(2)Brightness report	<input checked="" type="radio"/> No <input type="radio"/> Yes
Constant brightness A	(3)Temperature report	<input checked="" type="radio"/> No <input type="radio"/> Yes
A: Trigger	(4)Humidity report	<input checked="" type="radio"/> No <input type="radio"/> Yes
Logic function A	(5)Dry contact 1 report	<input checked="" type="radio"/> No <input type="radio"/> Yes
Block A	(6)Dry contact 2 report	<input checked="" type="radio"/> No <input type="radio"/> Yes
A1: Switching		
Logic function B		
Logic function C		
Logic function D		
Logic function E		

Fig 8 : Function Status Parameter Page

3.5.1. Parameters List

PARAMETERS	DESCRIPTION	VALUES
(1)Slave microwave sensor status report	This parameter, is used to enable or disable slave microwave sensor status report.	No Yes
-> Transmit telegram value when microwave sensor detected* ¹	This parameter, is used to set the transmit telegram value when movement detected.	Slave value '0' Slave value '1'
(2)Brightness report	This parameter, is used to enable or disable the lux value report feature.	No Yes
-> Lux report mode* ²	This parameter, is used to set the lux value report mode. Report when changed: It is reported when the lux value is changed. Report cyclic: The lux value is reported cyclically.	Report cyclic Report when changed
-> Differential value for report (1...200lux)* ²	This parameter, is used to set the differential lux value for report.	1... 20 ...200
-> Minimum time interval(1...255s)* ²	This parameter, is used to set the minimum time interval in seconds to report when there is a change of value.	1...255
-> Lux report cycle (1...255s)* ²	This parameter, is used to set the time for lux report cycle.	1... 10 ...255
(3)Temperature report	This parameter, is used to enable or disable the temperature value report feature.	No Yes
-> Temperature report mode* ³	This parameter, is used to set the temperature value report mode. Report when changed: It is reported when the temperature value is changed. Report cyclic: The temperature value is reported cyclically.	Report cyclic Report when changed
-> Differential value for report (0.1'C)* ³	This parameter, is used to set the differential temperature value for report.	1... 10 ...50
-> Temperature report cycle (1...255s)* ³	This parameter, is used to set the time for temperature report cycle.	1... 10 ...255
(4)Humidity report	This parameter, is used to enable or disable the humidity value report feature.	No Yes

-> Humidity report mode* ⁴	This parameter, is used to set the humidity value report mode. Report when changed: It is reported when the humidity value is changed. Report cyclic: The humidity value is reported cyclically.	Report when changed Report cyclic
-> Differential value for report (1..10%)* ⁴	This parameter, is used to set the differential humidity value for report.	1...3...10%
-> Humidity report cycle(1...255s)* ⁴	This parameter, is used to set the time for humidity report cycle.	1...10...255
(5)Dry contact 1 report	This parameter, is used to enable or disable the dry contact 1 report feature.	No Yes
-> Dry contact 1 report mode* ⁵	This parameter, is used to set the dry contact 1 report mode.	Contact action When status value changed True False Contact action and periodically When status value changed and periodically True and periodically False and periodically
->> Report cycle time(1...255s)* ⁵	This parameter, is used to set the cycle time of the reporting periodically.	1...10...255
(6)Dry contact 2 report	This parameter, is used to enable or disable the dry contact 2 report feature.	No Yes
-> Dry contact 2 report mode* ⁶	This parameter, is used to set the dry contact 2 report mode.	Contact action When status value changed True False Contact action and periodically When status value changed and periodically True and periodically False and periodically
->> Report cycle time(1...255s)* ⁶	This parameter, is used to set the cycle time of the reporting periodically.	1...10...255

*¹ This parameter, is only visible when the parameter "(1)Slave microwave sensor status report" is set to "Yes".

*² This parameter, is only visible when the parameter "(2)Brightness report" is set to "Yes".

*³ This parameter, is only visible when the parameter "(3)Temperature report" is set to "Yes".

*4 This parameter, is only visible when the parameter “(4)Humidity report” is set to “Yes”.

*5 This parameter, is only visible when the parameter “(5)Dry contact 1 report” is set to “Yes”.

*6 This parameter, is only visible when the parameter “(6)Dry contact 2 report” is set to “Yes”.

3.6. DRY CONTACT FUNCTION

When the parameter “Extend dry contact function” is activated from the general parameter page, the “Dry contact function” parameter page is displayed in the parameter page list. 2 separate dry contact inputs can be configured separately according to the contact types. Switching, dimming, scenario and percentage control can be performed with regard to the selected contact type, and if a LED is connected, the status information for this LED can also be configured. The following window is opened when entered to the “Dry contact function” parameter page.

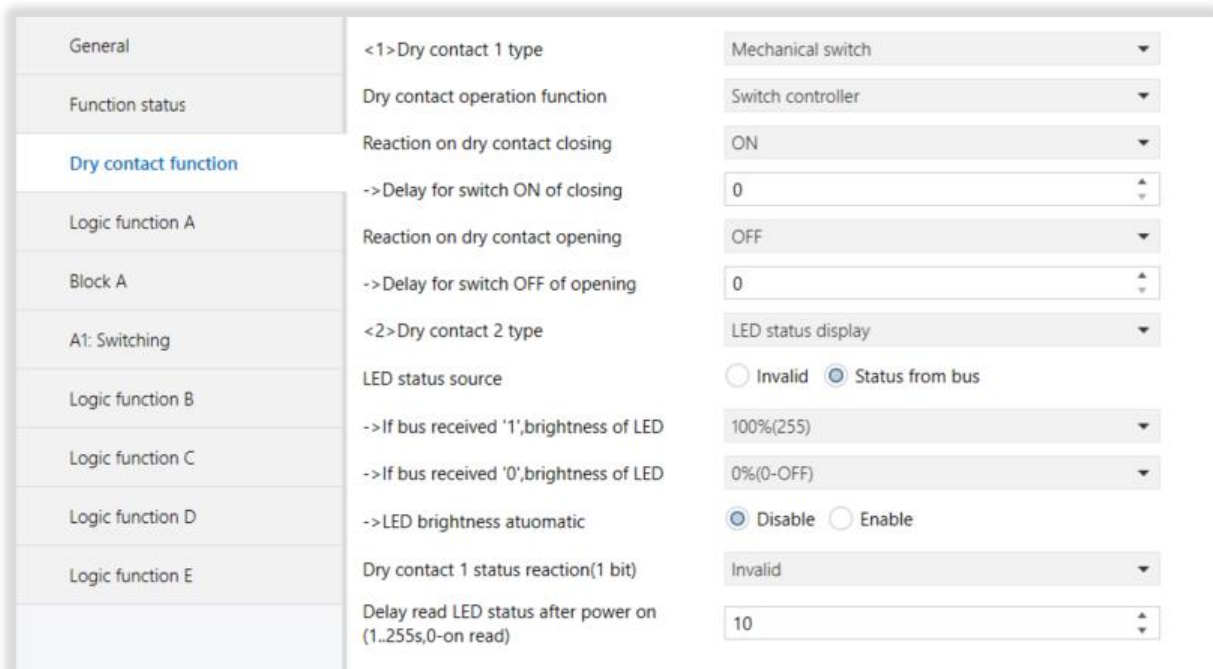

Fig 9 : Dry Contact Function Parameter Page

3.6.1. Parameters List

PARAMETERS	DESCRIPTION	VALUES
<1>Dry contact 1 type	This parameter, is used to set the dry contact 1 type	Invalid Mechanical switch Electronic switch LED status display
Dry contact operation function	This parameter, is used to set the parameter for movement sensor.	Switch controller Dimming controller Scene controller Percentage controller
Reaction on dry contact closing	This parameter, is used to set which function to perform when the dry contact is closed.	Invalid Toggle ON OFF
-> Delay for switch ON of closing	This parameter, is used to set a time delay for the function it will perform when the dry contact is switched on.	0...255
-> Delay for switch OFF of closing	This parameter, is used to set a time delay for the function it will perform when the dry contact is switched off.	0...255
Reaction on dry contact opening	This parameter, is used to set the function to perform when the dry contact is opened.	Invalid Toggle ON OFF
-> Delay for switch ON of closing	This parameter, is used to set a time delay for the function it will perform when the dry contact is switched on.	0...255
-> Delay for switch OFF of closing	This parameter, is used to set a time delay for the function it will perform when the dry contact is switched off.	0...255
Reaction on dry contact closing	This parameter, is used to set which function to perform when the dry contact is closed.	Invalid Dim->Brighter Dim->Darker Dim->Brighter/Darker Dim->Stop

-> Delay operation for dry contact closing	This parameter, is used to set a time delay for the function it will perform when the dry contact is closed.	0...255
Reaction on dry contact opening	This parameter, is used to set the function to perform when the dry contact is opened.	Invalid Dim->Brighter Dim->Darker Dim->Brighter/Darker Dim->Stop
-> Delay operation for dry contact opening	This parameter, is used to set a time delay for the function it will perform when the dry contact is opened.	0...255
Dimming steps	This parameter, is used to set the dimming steps.	Step1(100%) Step2(50%) Step3(25%) Step4(12.5%) Step5(6.25%) Step6(3.13%) Step7(1.65%)
Dimming telegram repeat enabled(valid only when dimming up/down)	This parameter, is used to enable or disable the dimming telegram repeat enabled.	Enable Disable
-> Dimming telegram repeat time 0.1s (0.2-20s)	This parameter, is used to set the dimming telegram repeat time.	2... 10 ...200
-> Dimming telegram repeat Number (1...255, 0-unlimited)	This parameter, is used to set the dimming telegram repeat number.	0... 10 ...255
Reaction on dry contact closing	This parameter, is used to set the function to perform when the dry contact is closed.	Invalid Scene NO.01 ...SceneNo.64
-> Delay operation for dry contact closing	This parameter, is used to set a time delay for the function it will perform when the dry contact is closed.	0...255
Reaction on dry contact opening	This parameter, is used to set the function to perform when the dry contact is opened.	Invalid Scene NO.01... SceneNo.02 ...Scene NO.64
-> Delay operation for dry contact opening	This parameter, is used to set a time delay for the function it will perform when the dry contact is opened.	0...255
Reaction on dry contact closing	This parameter, is used to set the function to perform when the dry contact is closed.	Invalid 0%(0-OFF)... 100%(255)

-> Delay operation for dry contact closing	This parameter, is used to set a time delay for the function it will perform when the dry contact is closed.	0...255
Reaction on dry contact opening	This parameter, is used to set the function to perform when the dry contact is opened.	Invalid 0%(0-OFF)...100%(255)
-> Delay operation for dry contact opening	This parameter, is used to set a time delay for the function it will perform when the dry contact is opened.	0...255
Led status source	This parameter, is used to determine whether the LED status has been received from the bus line.	Invalid Status from bus
-> If bus received '1', brightness of LED	This parameter, is used to set the brightness of the LED when the '1' LED value is taken from the bus line.	0...100%
-> If bus received '0', brightness of LED	This parameter, is used to set the brightness of the LED when the '0' LED value is taken from the bus line.	0...100%
-> LED brightness automatic	This parameter, is used to enable or disable the automatic adjustment of the LED brightness.	Disable Enable
->>Automatic dim after a delay(1...255S)	This parameter, is used to set a time delay for automatic dimming.	1...10...255
->>If bus received '1',brightness of LED	This parameter, is used to set the brightness of the LED when the '1' LED value is taken from the bus line.	0...5...255%
->>If bus received '0',brightness of LED	This parameter, is used to set the brightness of the LED when the '0' LED value is taken from the bus line.	0...100%
Dry contact 2 status reaction(1 bit)	This parameter, is used to set reaction of the dry contact 2 status	Invalid Short button Invert to short button Long button Invert to long button Short & long button Invert to short & long button (Invert to short) & long button short & (Invert to long) button Closing & opening when toggle Inver to closing & opening when toggle

Delay read LED status after power on(1...255s,0-on read)	This parameter, is used to set a delay time for reading the LED status after the power has been received.	0...10...255
<2>Dry contact 2 type	All setting is same as 1.	All setting is same as 1.

3.7. LOGIC FUNCTION

At the ITR411-002 device's parameter page, up to 5 different functions can be defined for logic operations. Various logic combinations can be defined and the desired configurations can be made. Since the parameters of these functions are exactly the same, only 1 of them is explained. The following window is displayed when entering the pencere Logic function A parameter page.

Fig 10 : Logic Function A Parameter Page

3.7.1. Parameters List

PARAMETERS	DESCRIPTION	VALUES
Use logical block A	This parameter, is used to enable or disable the using logical block A.	Yes No
(1)Enable microwave sensor	This parameter, is used to set enabling the microwave sensor.	Disable Single mode(independent sensor) Master/slave mode(Master sensor)
-> Microwave sensor status	This parameter, is used to set the microwave sensor status.	Microwave sensor detected is False, else is True Microwave sensor detected is True, else is False
-> Local microwave sensor status	This parameter, is used to set for local microwave sensor status.	Microwave sensor detected is False, else is True Microwave sensor detected is True, else is False
-> Master is set to True when receive	This parameter, is used to set the Master sensor to True value when received slave sensor values.	Slave value-'0' Slave value-'1'
(2)Enable brightness(Lux) sensor	This parameter, is used to enable or disable the lux sensor.	Enable Disable
Enable brightness(Lux) threshold A	This parameter, is used to enable or disable lux threshold A value.	Enable Disable
-> Lux>=Threshold lower (0~15k lux)	This parameter, is used to set the lux threshold lower value.	0... 100 ...15000
-> Lux<=Threshold upper (0~15k lux)	This parameter, is used to set the lux threshold upper value.	0... 300 ...15000
-> Changed lux threshold value via bus	This parameter, is used to enable or disable for changing lux threshold value via bus line. Yes : Lux threshold value can be changed via bus line. No : Lux threshold value can not be changed via bus line.	Yes No

-> Brightness(Lux) status	This parameter, is used to set the lux status.	In range is True, else False Out range is True, else False Under lower is True, above upper is False Under lower is False, above upper is True
-->>The status after bus voltage recovery	This parameter, is used to set the status after bus voltage recovery.	True False
-> Independent control <object output 8>	This parameter, is used to enable or disable the independent control <object output 8>	No Yes(separated from logic and output)
-->>Enable/disable independent control via bus	This parameter, is used to enable or disable the independent control via bus. Yes : Enable independent control via bus. No : Disable independent control via bus.	Yes No
-->>Operation mode	This parameter, is used to set the operation mode.	'1'-Enable, '0'-Disable '0'-Enable, '1'-Disable '1/0'-Disable '1/0'-Enable '1'-Enable, '0'-Invalid '0'-Enable, '1'-Invalid '1'-Disable, '0'-Invalid '0'-Disable, '1'-Invalid
-->><Object output 8> status when independent control disabled	This parameter, is used to set the object output 8 status.	Unchanged True False True and immediately output False and immediately output
(3)Enable temperature sensor	This parameter, is used to enable or disable the temperature sensor.	Enable Disable
->Temperature>=Threshold lower (0.1'C)	This parameter, is used to set the temperature threshold lower value.	-300... 220 ...700
->Temperature<=Threshold upper (0.1'C)	This parameter, is used to set the temperature threshold upper value.	-300... 260 ...700

->changed temperature threshold value via bus	This parameter, is used to enable or disable for changing temperature threshold value via bus. Yes: Can change temperature threshold value via bus. No: Can not change temperature threshold value via bus.	Yes No
->Temperature status	This parameter, is used to set the temperature status.	In range is True, else False Out range is True, else False Under lower is True, above upper is False Under lower is False, above upper is True
-->>The status after bus voltage recovery	This parameter, is used to set the temperature status after bus voltage recovery.	True False
(4)Enable humidity sensor	This parameter, is used to enable or disable the humidity sensor.	Enable Disable
->Humidity>=Threshold lower (20%...95%)	This parameter, is used to set the humidity threshold lower value.	20...95
->Humidity<=Threshold upper (20%...95%)	This parameter, is used to set the humidity threshold upper value.	20...60...95
->Changed humidity threshold value via bus	This parameter, is used to enable or disable for changing temperature threshold value via bus. Yes: Can change humidity threshold value via bus. No: Can not change humidity threshold value via bus.	Yes No
->Humidity status	This parameter, is used to set the humidity status.	In range is True, else False Out range is True, else False Under lower is True, above upper is False Under lower is False, above upper is True
-->>The status after bus voltage recovery	This parameter, is used to set the humidity status after bus voltage recovery.	True False

Enable external telegram 1	This parameter, is used to enable or disable the external telegram 1.	Disable 1 bit value('1'/'0') 1 byte threshold (0...255) 2 bytes threshold (0...65535) 2 bytes float threshold (-50°C...100°C) 4 bytes threshold 0...2147483647
->Extern telegram status	This parameter, is used to set the external telegram status.	'1' is True, '0' is False '0' is True, '1' is False
->Default status after bus voltage recovery	This parameter, is used to set the default status after bus voltage recovery.	True False Recovery
->1 byte threshold (0...255)	This parameter, is used to set the 1 byte threshold value.	0... 100 ...255
->Extern telegram status	This parameter, is used to set the external telegram status.	True if REV value >= Threshold, else False True if REV value <= Threshold, else False
->2 byte threshold (0...65535)	This parameter, is used to set the 2 byte threshold value.	0... 1000 ...65535
->2 byte float threshold (0.1°C)	This parameter, is used to set the 2 byte float threshold value.	-500... 250 ...1000
->4 byte threshold (0...2147483647)	This parameter, is used to set the 4 byte threshold value.	0... 1000000 ...2147483647
Enable external telegram 2	All settings is same as 1.	All settings is same as 1.
Enable dry contact 1 input	This parameter, is used to enable or disable the dry contact 1.	Enable Disable
->Dry contact 1 status	This parameter, is used to set the dry contact 1 status.	'1' is True, '0' is False '0' is True, '1' is False
Enable dry contact 2 input	All settings is same as 1.	All settings is same as 1.
Logical relation of block A	This parameter, is used to set for logical relation of block A. AND : All conditions should be satisfied. OR : One condition is satisfied, the logic will trigger.	AND OR
Result of logic A inverted	This parameter, is used to enable or disable for result of logical A inverted.	Yes No

<p>Status(True/False) of logic A to bus</p>	<p>This parameter, is used to enable or disable the status of logic A to bus.</p>	<p>Enable Disable</p>
<p>->Send status when</p>	<p>This parameter, is used to set when the status value will be sent.</p> <p>Status changed: When the status is changed, the value will be sent.</p> <p>Status is True: When the status is true, the value will be sent.</p> <p>Status is False: When the status is false, the value will be sent.</p> <p>Status changed and periodically: If the status is changed, the value will be sent periodically.</p> <p>Status is True and periodically: If the status is true, the value will be sent periodically.</p> <p>Status is False and periodically: If the status is false, the value will be sent periodically.</p>	<p>Status changed Status is True Status is False Status changed and periodically Status is True and periodically Status is False and periodically</p>
<p>->Cycle time(1...255s)</p>	<p>This parameter, is used to set the cycle time.</p>	<p>1...10...255</p>
<p><1>Logical A function 'Enable/disable' status</p>	<p>This parameter, is used to enable or disable the logical A function status.</p> <p>Yes: Logical A function 'enable/disable' status can be used.</p> <p>No: Logical A function 'enable/disable' status can not be used.</p>	<p>Yes No</p>
<p>->Telegram via bus</p>	<p>This parameter, is used to enable or disable receiving telegrams via bus.</p>	<p>Disable Enable</p>
<p>-->>Operation mode</p>	<p>This parameter, is used to set the operation mode of the related telegram.</p>	<p>'1'-Enable,'0'-Disable '0'-Enable,'1'-Disable '1/0'-Disable '1/0'-Enable '1'-Enable,'0'-Invalid '0'-Enable,'1'-Invalid '0'-Disable,'1'-Invalid '1'-Disable,'0'-Invalid</p>
<p>->Dry contact 1</p>	<p>This parameter, is used to enable or disable the dry contact 1.</p>	<p>Enable Disable</p>

<p>-->>Operation mode</p>	<p>This parameter, is used to set the operation mode of dry contact 1.</p>	<p>'1'-Enable,'0'-Disable '0'-Enable,'1'-Disable '1/0'-Disable '1/0'-Enable '1'-Enable,'0'-Invalid '0'-Enable,'1'-Invalid '0'-Disable,'1'-Invalid '1'-Disable,'0'-Invalid</p>
<p>Logic A output status when logic function disabled</p>	<p>This parameter, is used to set the logic A output status when logic function disabled.</p> <p>Unchanged: When logic function is disabled, logic A output will not be changed.</p> <p>True: When logic function is disabled, logic A output will be set to True.</p> <p>False: When logic function is disabled, logic A output will be set to False.</p> <p>True and immediately output: When logic function is disabled, logic A output will be set to True immediately.</p> <p>False and immediately output: When logic function is disabled, logic A output will be set to False immediately.</p>	<p>Unchanged True False True and immediately output False and immediately output</p>
<p>->Logic A automatic enabled after logic function disabled</p>	<p>This parameter, is used to set the automatic activation of logic A when the logic function is disabled.</p>	<p>Yes No</p>
<p>-->>Delay time (0...17hours)</p>	<p>This parameter, is used to set the time delay in hours.</p>	<p>0...17</p>
<p>-->>Delay time (0...59min)</p>	<p>This parameter, is used to set the time delay in minutes.</p>	<p>0...59</p>
<p>-->>Delay time (0...59sec)</p>	<p>This parameter, is used to set the time delay in seconds.</p>	<p>0...30...59</p>
<p><2>Logical A function 'Enable/Disable' status control</p>	<p>All setting is same as <1></p>	<p>All setting is same as <1></p>

<p>Logic A output status when logic function enabled</p>	<p>This parameter, is used to set the logic A output status when logic function is enabled.</p> <p>True: When logic function is enabled, logic A output will be set to True.</p> <p>False: When logic function is enabled, logic A output will be set to False.</p> <p>Current logic status: When logic function is enabled, logic A output will be set to current logic status.</p>	<p>False</p> <p>True</p> <p>Current logic status</p>
<p>Feedback logic A function enable/disable status</p>	<p>This parameter, is used to enable or disable the feedback logic A function status.</p> <p>Yes: Feedback logic A function 'enable/disable' status will be enabled.</p> <p>No: Feedback logic A function 'enable/disable' status will be disabled.</p>	<p>Yes</p> <p>No</p>

3.8. BLOCK A

At the ITR411-002 device's parameter page, up to 5 different functions for logic operations can be defined, hence the blocks which are related to functions can also be defined. Independent controllers can be determined for 10 different output objects. Switching, dimming, shutter, alarm, percentage, sequence, scenario, string and threshold values can be controlled. As the parameters of the logic functions are exactly the same, the blocks of the functions are the same, too. Consequently, only 1 block is explained here. The following window is displayed when entering the Block A parameter page.

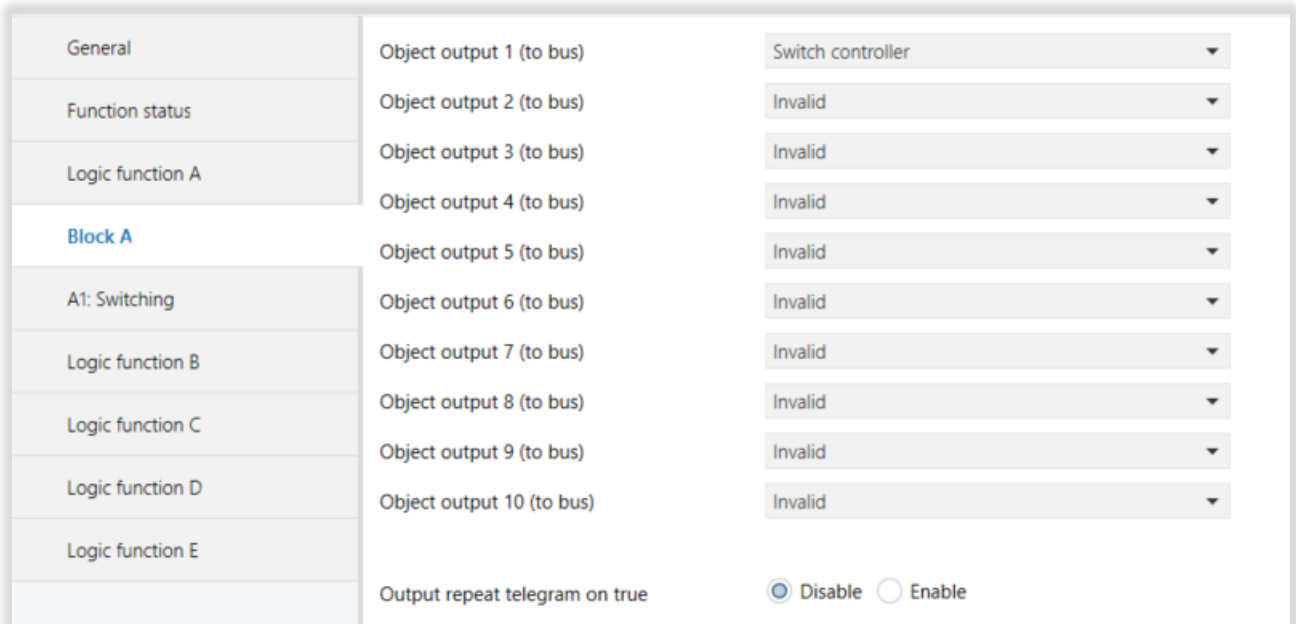

Fig 11 : Block A Parameter Page

3.8.1. Parameters List

PARAMETERS	DESCRIPTION	VALUES
Object output 1-10 (to bus)	This parameter, is used to set the object output 1-10 to bus.	Invalid Switch controller Absolute dimming controller Shutter controller Alarm controller Percentage controller Sequence controller Scene controller String (14bytes) controller Threshold controller
Output repeat telegram on true	This parameter, is used to enable or disable the output repeat telegram on true value.	Enable Disable
-> Repeat time interval (0...59min)	This parameter, is used to set the time for repeat time interval in minutes.	0...2...59
-> Repeat time interval (0...59sec)	This parameter, is used to set the time for repeat time interval in seconds.	0...59

3.9. A1:SWITCHING

At the ITR411-002 device's parameter page, different controllers can be determined for the 10 different output objects. Switching control and parameters are described in this chapter. Since all output objects are the same, only 1 output object is described here. The following window is displayed when entering the A1:Switching parameter page.

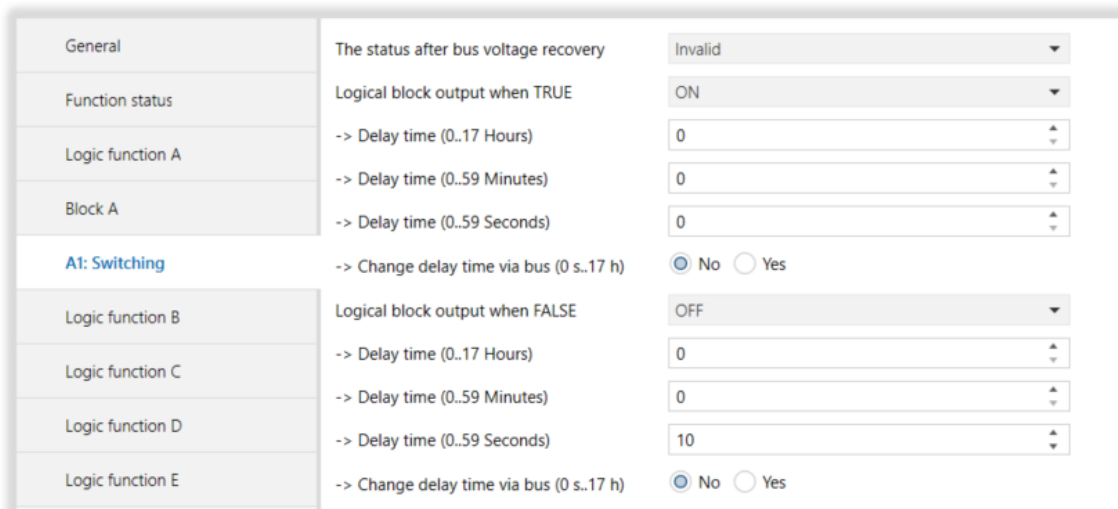

Fig 12 : A1:Switching Parameter Page

3.9.1. Parameters List

PARAMETERS	DESCRIPTION	VALUES
The status after bus voltage recovery	This parameter, is used to set the status after bus voltage recovery.	Invalid ON OFF Recovery
Logical block output when TRUE	This parameter, is used to set the function when logic block output is true.	Invalid OFF ON Toggle
-> Delay time (0...17 Hours)	This parameter, is used to set the time delay in hours.	0...17
-> Delay time (0...59 Min)	This parameter, is used to set the time delay in minutes.	0...59
-> Delay time (0...59 Sec)	This parameter, is used to set the time delay in seconds.	0...59
-> Change delay time via bus (0s...17h)	This parameter, is used to set the changing delay time via bus. Yes: The delay time can be changed via bus. No: The delay time can not be changed via bus.	Yes No
Logical block output when FALSE	This parameter, is used to set the function when logic block output is false.	Invalid OFF ON Toggle
-> Delay time (0...17 Hours)	This parameter, is used to set the time delay in hours.	0...17
-> Delay time (0...59 Min)	This parameter, is used to set the time delay in minutes.	0...59
-> Delay time (0...59 Sec)	This parameter, is used to set the time delay in seconds.	0...10...59
-> Change delay time via bus (0s...17h)	This parameter, is used to set the changing delay time via bus. Yes: The delay time can be changed via bus. No: The delay time can not be changed via bus.	Yes No

3.10. A1:DIMMING

ITR411-002 device's one of the parameter page is dimming control and its parameters are described in this section. Since all output objects are the same, only 1 output object is described here. The following window is opened when entered to the "A1:Dimming" parameter page.

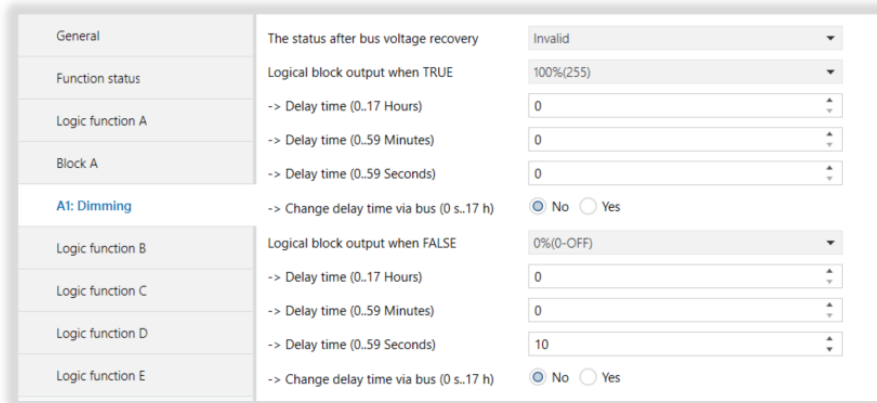

Fig 13 : A1:Dimming Parameter Page

3.10.1. Parameters List

PARAMETERS	DESCRIPTION	VALUES
The status after bus voltage recovery	This parameter, is used to set the status after bus voltage recovery.	Invalid Recovery Defined dimming
-> Recovery defined dimming	This parameter, is used to set the recovery defined dimming value after bus voltage recovery.	Invalid 0%(0-OFF)...100%(255)
Logical block output when TRUE	This parameter, is used to set the function when logic block output is true.	Invalid 0%(0-OFF)...100%(255)
-> Delay time (0...17 Hours)	This parameter, is used to set the time delay in hours.	0...17
-> Delay time (0...59 Min)	This parameter, is used to set the time delay in minutes.	0...59
-> Delay time (0...59 Sec)	This parameter, is used to set the time delay in seconds.	0...59
-> Change delay time via bus (0s...17h)	This parameter, is used to set the changing delay time via bus. Yes: The delay time can be changed via bus. No: The delay time can not be changed via bus.	Yes No
Logical block output when FALSE	This parameter, is used to set the function when logic block output is false.	Invalid 0%(0-OFF)...100%(255)

-> Delay time (0...17 Hours)	This parameter, is used to set the time delay in hours.	0...17
-> Delay time (0...59 Min)	This parameter, is used to set the time delay in minutes.	0...59
-> Delay time (0...59 Sec)	This parameter, is used to set the time delay in seconds.	0...10...59
-> Change delay time via bus (0s...17h)	This parameter, is used to set the changing delay time via bus. Yes: The delay time can be changed via bus. No: The delay time can not be changed via bus.	Yes No

3.11. A1:SHUTTER

ITR411-002 device's one of the parameter page is shutter control and its parameters are described in this section. Since all output objects are the same, only 1 output object is described here. The following window is opened when entered to the "A1:Shutter" parameter page.

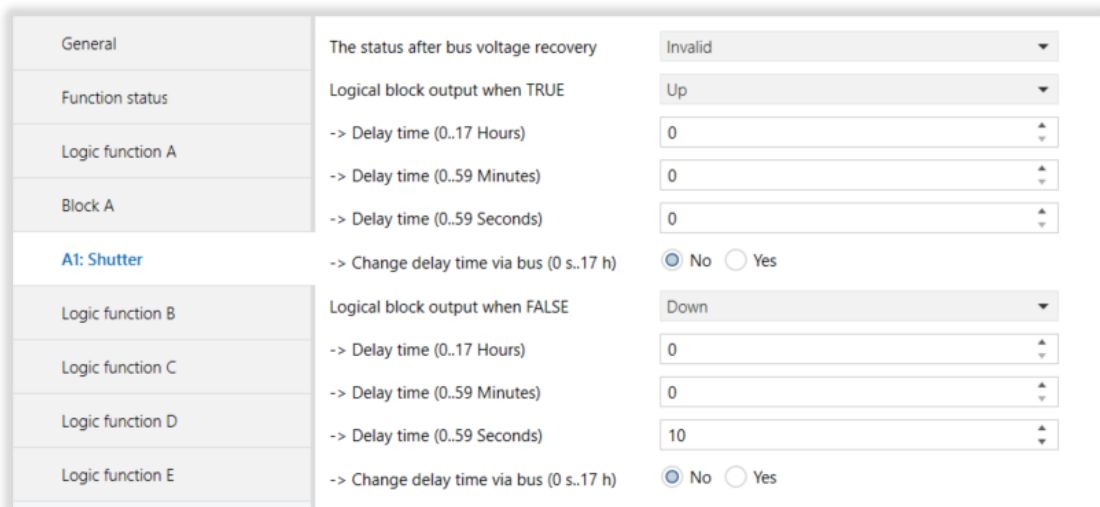

Fig 14 : A1:Shutter Parameter Page

3.11.1. Parameters List

PARAMETERS	DESCRIPTION	VALUES
The status after bus voltage recovery	This parameter, is used to set the status after bus voltage recovery.	Invalid UP Down Recovery
Logical block output when TRUE	This parameter, is used to set the function when logic block output is true.	Invalid Up Down Toggle
-> Delay time (0...17 Hours)	This parameter, is used to set the time delay in hours.	0...17
-> Delay time (0...59 Min)	This parameter, is used to set the time delay in minutes.	0...59
-> Delay time (0...59 Sec)	This parameter, is used to set the time delay in seconds.	0...59
-> Change delay time via bus (0s...17h)	This parameter, is used to set the changing delay time via bus. Yes: The delay time can be changed via bus. No: The delay time can not be changed via bus.	Yes No
Logic block output when FALSE	This parameter, is used to set the function when logic block output is false.	Invalid 0%(0-OFF)...100%(255)
-> Delay time (0...17 Hours)	This parameter, is used to set the time delay in hours.	0...17
-> Delay time (0...59 Min)	This parameter, is used to set the time delay in minutes.	0...59
-> Delay time (0...59 Sec)	This parameter, is used to set the time delay in seconds.	0...10...59
-> Change delay time via bus (0s...17h)	This parameter, is used to set the changing delay time via bus. Yes: The delay time can be changed via bus. No: The delay time can not be changed via bus.	Yes No

3.12. A1:ALARM

ITR411-002 device's one of the parameter page is alarm control and its parameters are described in this section. Since all output objects are the same, only 1 output object is described here. The following window is opened when entered to the "A1:Alarm" parameter page.

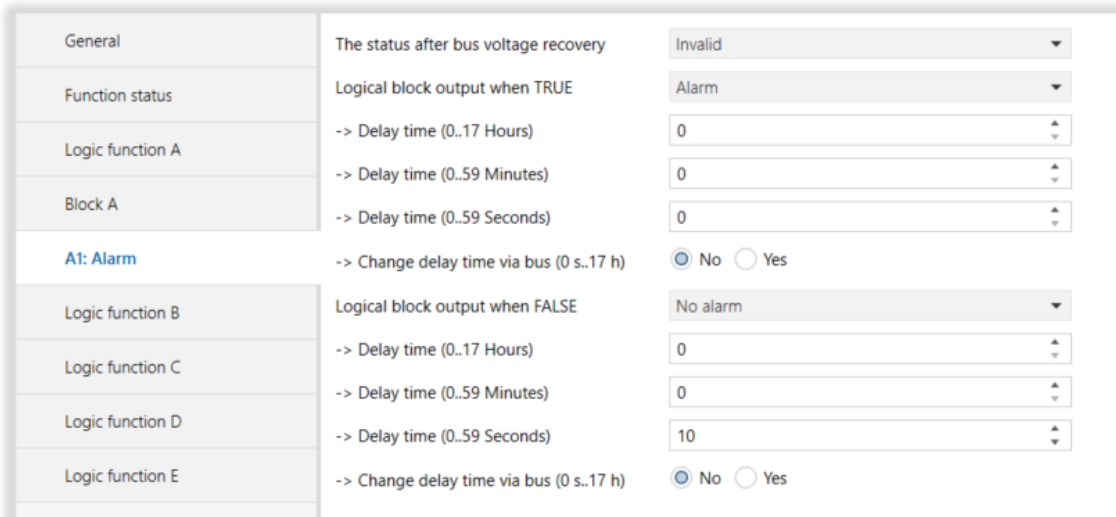

Fig 15 : A1:Alarm Parameter Page

3.12.1. Parameters List

PARAMETERS	DESCRIPTION	VALUES
The status after bus voltage recovery	This parameter, is used to set the status after bus voltage recovery.	Invalid No alarm Alarm Recovery
Logical block output when TRUE	This parameter, is used to set the function when logic block output is true.	Invalid Alarm No alarm Toggle
-> Delay time (0...17 Hours)	This parameter, is used to set the time delay in hours.	0...17
-> Delay time (0...59 Min)	This parameter, is used to set the time delay in minutes.	0...59
-> Delay time (0...59 Sec)	This parameter, is used to set the time delay in seconds.	0...59

-> Change delay time via bus (0s...17h)	This parameter, is used to set the changing delay time via bus. Yes: The delay time can be changed via bus. No: The delay time can not be changed via bus.	Yes No
Logic block output when FALSE	This parameter, is used to set the function when logic block output is false.	Invalid Alarm No alarm Toggle
-> Delay time (0...17 Hours)	This parameter, is used to set the time delay in hours.	0...17
-> Delay time (0...59 Min)	This parameter, is used to set the time delay in minutes.	0...59
-> Delay time (0...59 Sec)	This parameter, is used to set the time delay in seconds.	0...10...59
-> Change delay time via bus (0s...17h)	This parameter, is used to set the changing delay time via bus. Yes: The delay time can be changed via bus. No: The delay time can not be changed via bus.	Yes No

3.13. A1:PERCENTAGE

ITR411-002 device's one of the parameter page is percentage control and its parameters are described in this section. Since all output objects are the same, only 1 output object is described here. The following window is opened when entered to the "A1:Percentage" parameter page.

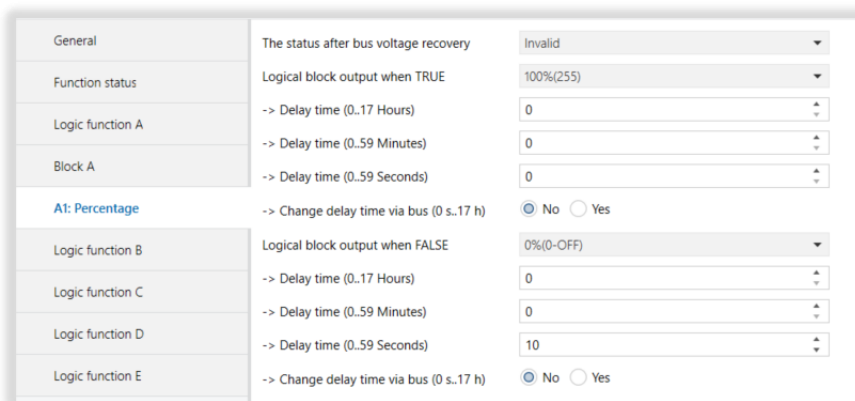

Fig 16 : A1:Percentage Parameter Page

3.13.1. Parameters List

PARAMETERS	DESCRIPTION	VALUES
The status after bus voltage recovery	This parameter, is used to set the status after bus voltage recovery.	Invalid Recovery
-> Recovery defined percentage	This parameter, is used to set the recovery defined percentage after bus voltage recovery.	Invalid 0%(0-OFF)...100%(255)
Logical block output when TRUE	This parameter, is used to set the function when logic block output is true.	Invalid 0%(0-OFF)...100%(255)
-> Delay time (0...17 Hours)	This parameter, is used to set the time delay in hours.	0...17
-> Delay time (0...59 Min)	This parameter, is used to set the time delay in minutes.	0...59
-> Delay time (0...59 Sec)	This parameter, is used to set the time delay in seconds.	0...59
-> Change delay time via bus (0s...17h)	This parameter, is used to set the changing delay time via bus. Yes: The delay time can be changed via bus. No: The delay time can not be changed via bus.	Yes No
Logic block output when FALSE	This parameter, is used to set the function when logic block output is false.	Invalid Alarm No alarm Toggle
-> Delay time (0...17 Hours)	This parameter, is used to set the time delay in hours.	0...17
-> Delay time (0...59 Min)	This parameter, is used to set the time delay in minutes.	0...59
-> Delay time (0...59 Sec)	This parameter, is used to set the time delay in seconds.	0...10...59
-> Change delay time via bus (0s...17h)	This parameter, is used to set the changing delay time via bus. Yes: The delay time can be changed via bus. No: The delay time can not be changed via bus.	Yes No

3.14. A1:SEQUENCE

ITR411-002 device's one of the parameter page is sequence control and its parameters are described in this section. Since all output objects are the same, only 1 output object is described here. The following window is opened when entered to the "A1:Sequence" parameter page.

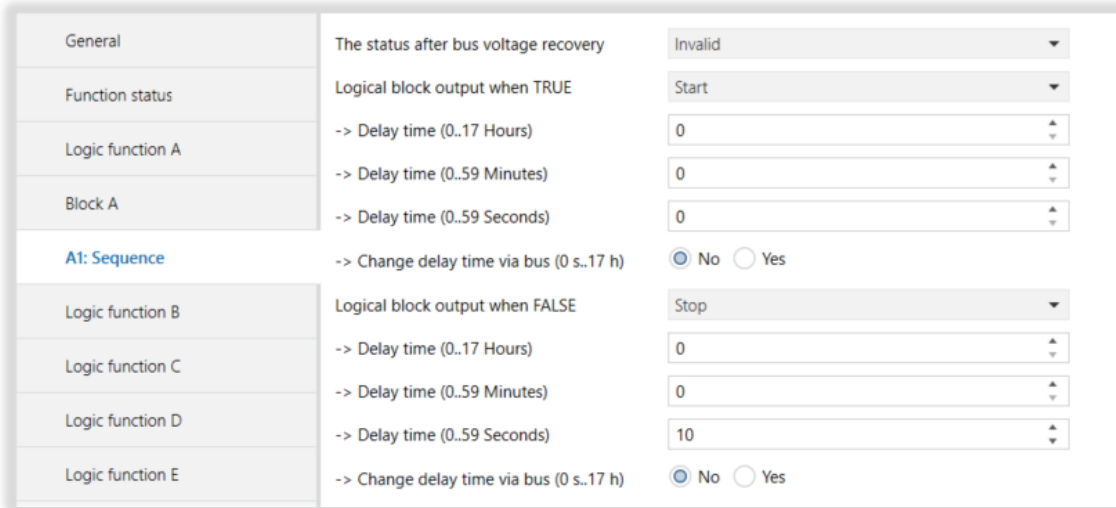

Fig 16 : A1:Sequence Parameter Page

3.14.1. Parameters List

PARAMETERS	DESCRIPTION	VALUES
The status after bus voltage recovery	This parameter, is used to set the status after bus voltage recovery.	Invalid Stop Start Recovery
Logical block output when TRUE	This parameter, is used to set the function when logic block output is true.	Invalid Stop Start Toggle
-> Delay time (0...17 Hours)	This parameter, is used to set the time delay in hours.	0...17
-> Delay time (0...59 Min)	This parameter, is used to set the time delay in minutes.	0...59
-> Delay time (0...59 Sec)	This parameter, is used to set the time delay in seconds.	0...59

-> Change delay time via bus (0s...17h)	This parameter, is used to set the changing delay time via bus. Yes: The delay time can be changed via bus. No: The delay time can not be changed via bus.	Yes No
Logic block output when FALSE	This parameter, is used to set the function when logic block output is false.	Invalid Stop Start Recovery
-> Delay time (0...17 Hours)	This parameter, is used to set the time delay in hours.	0...17
-> Delay time (0...59 Min)	This parameter, is used to set the time delay in minutes.	0...59
-> Delay time (0...59 Sec)	This parameter, is used to set the time delay in seconds.	0...10...59
-> Change delay time via bus (0s...17h)	This parameter, is used to set the changing delay time via bus. Yes: The delay time can be changed via bus. No: The delay time can not be changed via bus.	Yes No

3.15. A1:SCENE

ITR411-002 device's one of the parameter page is scene control and its parameters are described in this section. Since all output objects are the same, only 1 output object is described here. The following window is opened when entered to the "A1:Scene" parameter page.

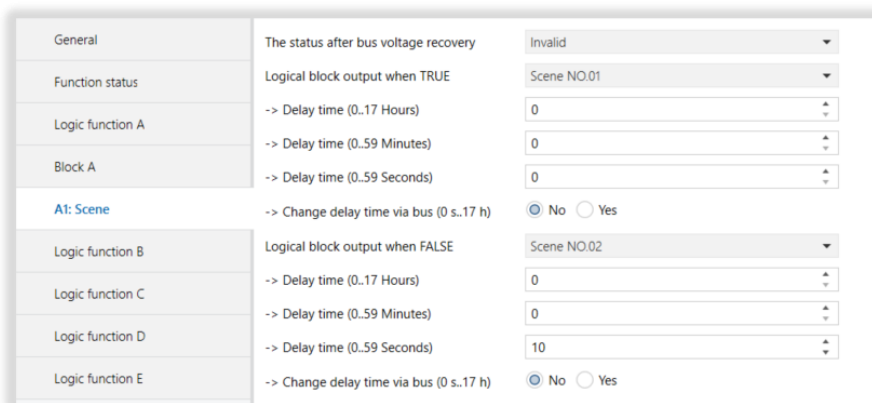

Fig 17 : A1:Scene Parameter Page

3.15.1. Parameters List

PARAMETERS	DESCRIPTION	VALUES
The status after bus voltage recovery	This parameter, is used to set the status after bus voltage recovery.	Invalid Recovery Defined Scene
Recovery defined scene NO.	This parameter, is used to set the recovery defined scene NO. after bus voltage recovery.	Scene NO.01..Scene NO.64
Logical block output when TRUE	This parameter, is used to set the function when logic block output is true.	Scene NO.01..Scene NO.64
-> Delay time (0...17 Hours)	This parameter, is used to set the time delay in hours.	0...17
-> Delay time (0...59 Min)	This parameter, is used to set the time delay in minutes.	0...59
-> Delay time (0...59 Sec)	This parameter, is used to set the time delay in seconds.	0...59
-> Change delay time via bus (0s...17h)	This parameter, is used to set the changing delay time via bus. Yes: The delay time can be changed via bus. No: The delay time can not be changed via bus.	Yes No
Logic block output when FALSE	This parameter, is used to set the function when logic block output is false.	Scene NO.01... NO.02 ... Scene NO.64
-> Delay time (0...17 Hours)	This parameter, is used to set the time delay in hours.	0...17
-> Delay time (0...59 Min)	This parameter, is used to set the time delay in minutes.	0...59
-> Delay time (0...59 Sec)	This parameter, is used to set the time delay in seconds.	0... 10 ...59
-> Change delay time via bus (0s...17h)	This parameter, is used to set the changing delay time via bus. Yes: The delay time can be changed via bus. No: The delay time can not be changed via bus.	Yes No

3.16. A1:STRING

ITR411-002 device's one of the parameter page is string function and its parameters are described in this section. Since all output objects are the same, only 1 output object is described here. The following window is opened when entered to the "A1:String" parameter page.

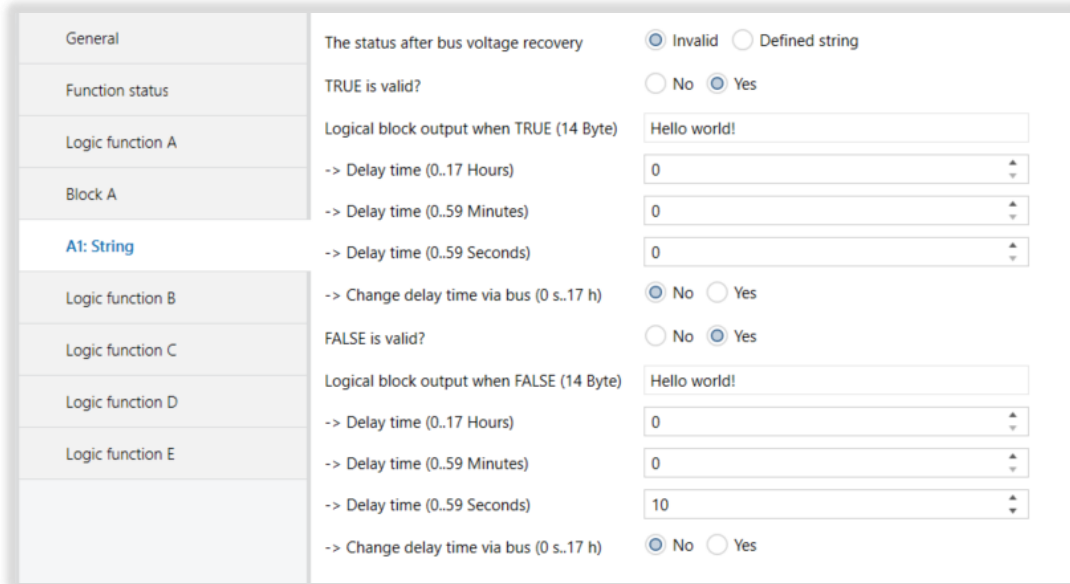

Fig 18 : A1:String Parameter Page

3.16.1. Parameters List

PARAMETERS	DESCRIPTION	VALUES
The status after bus voltage recovery	This parameter, is used to set the status after bus voltage recovery.	Invalid Defined String
Recovery defined string (14 Byte)	This parameter, is used to set the recovery defined string after bus voltage recovery(14 byte).	Hello world!
TRUE is valid?	This parameter, is used to enable or disable for true is valid. True: True is valid. No: True is invalid.	Yes No
Logical block output when TRUE (14 byte)	This parameter, is used to set the function when logic block output is true(14 byte).	Hello world!
-> Delay time (0...17 Hours)	This parameter, is used to set the time delay in hours.	0...17
-> Delay time (0...59 Min)	This parameter, is used to set the time delay in minutes.	0...59

-> Delay time (0...59 Sec)	This parameter, is used to set the time delay in seconds.	0...59
-> Change delay time via bus (0s...17h)	This parameter, is used to set the changing delay time via bus. Yes: The delay time can be changed via bus. No: The delay time can not be changed via bus.	Yes No
FALSE is valid?	This parameter, is used to enable or disable for false is valid. True: False is valid. No: False is invalid.	Yes No
Logical block output when FALSE (14 byte)	This parameter, is used to set the function when logic block output is false.	Hello world!
-> Delay time (0...17 Hours)	This parameter, is used to set the time delay in hours.	0...17
-> Delay time (0...59 Min)	This parameter, is used to set the time delay in minutes.	0...59
-> Delay time (0...59 Sec)	This parameter, is used to set the time delay in seconds.	0... 10 ...59
-> Change delay time via bus (0s...17h)	This parameter, is used to set the changing delay time via bus. Yes: The delay time can be changed via bus. No: The delay time can not be changed via bus.	Yes No

3.17. A1:THRESHOLD

ITR411-002 device’s one of the parameter page is threshold function and its parameters are described in this section. Since all output objects are the same, only 1 output object is described here. The following window is opened when entered to the “A1:Threshold” parameter page.

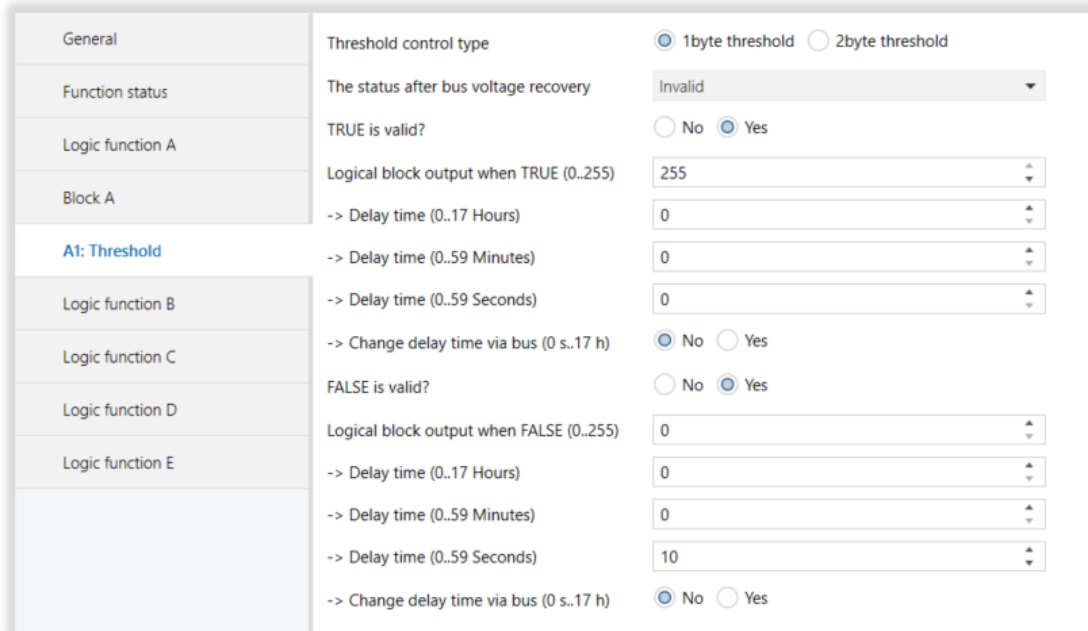

Fig 19 : A1:Threshold Parameter Page

3.17.1. Parameters List

PARAMETERS	DESCRIPTION	VALUES
Threshold control type	This parameter, is used to set the threshold control type.	1 byte threshold 2 byte threshold
The status after bus voltage recovery	This parameter, is used to set the status after bus voltage recovery.	Invalid Recovery Defined threshold
Recovery defined threshold (0...255)	This parameter, is used to set the recovery defined threshold after bus voltage recovery.	0...1...255
Recovery defined threshold (0...65535)	This parameter, is used to set the recovery defined threshold after bus voltage recovery.	0...65535
TRUE is valid?	This parameter, is used to enable or disable for true is valid. True: True is valid. No: True is invalid.	Yes No
Logical block output when TRUE (0...255)	This parameter, is used to set the function when logical block output value is True(1 byte).	0...255

Logical block output when TRUE (0...65535)	This parameter, is used to set the function when logical block output value is True(2 byte).	0...1000...65535
-> Delay time (0...17 Hours)	This parameter, is used to set the time delay in hours.	0...17
-> Delay time (0...59 Min)	This parameter, is used to set the time delay in minutes.	0...59
-> Delay time (0...59 Sec)	This parameter, is used to set the time delay in seconds.	0...59
-> Change delay time via bus (0s...17h)	This parameter, is used to set the changing delay time via bus. Yes: The delay time can be changed via bus. No: The delay time can not be changed via bus.	Yes No
FALSE is valid?	This parameter, is used to enable or disable for false is valid. True: False is valid. No: False is invalid.	Yes No
Logical block output when FALSE (0...255)	This parameter, is used to set the function when logical block output value is False(1 byte).	0...255
Logical block output when FALSE (0...65535)	This parameter, is used to set the function when logical block output value is False(2 byte).	0...65535
-> Delay time (0...17 Hours)	This parameter, is used to set the time delay in hours.	0...17
-> Delay time (0...59 Min)	This parameter, is used to set the time delay in minutes.	0...59
-> Delay time (0...59 Sec)	This parameter, is used to set the time delay in seconds.	0...10...59
-> Change delay time via bus (0s...17h)	This parameter, is used to set the changing delay time via bus. Yes: The delay time can be changed via bus. No: The delay time can not be changed via bus.	Yes No

4. ETS OBJECTS AND DESCRIPTIONS

It was mentioned above that there are parameters and functions with the same feature when making the relevant configurations from the parameter pages. The objects of the same properties are the same, and only the names of the objects are different. Hence, in this section, 1 of the objects with the same feature is explained.

4.1. GENERAL

At the following table, the objects associated with the general parameter page are described.

Object Name	Function	Type	Flags
General	Heartbeat telegram	1 bit	C T
This object, when set '0', will send the telegram value '0' cyclically, when set '1', will send the telegram value '1' cyclically; when set '0/1', will send the telegram value '0/1' cyclically.			
General	Microwave sensor sensitivity	1 Byte	C R W T
This object, is used to set the microwave sensor sensitivity.			
General	LED indicator status	1 bit	C R W T
This object, is used to set the LED indicator status.			

4.2. FUNCTION STATUS

At the following table, the objects associated with the function status are described.

Object Name	Function	Type	Flags
Function status	Microwave status to bus	1 bit	C W T
This object, is used to set the microwave sensor status to bus.			
Function status	Brightness (Lux) value	2 Byte	C R T
This object, is used to set the lux value.			
Function status	Temperature value	2 Byte	C R T
This object, is used to set the temperature value.			
Function status	Humidity value	2 Byte	C R T
This object, is used to set the humidity value.			
Function status	Dry contact 1 status	1 bit	C R T
This object, is used to set the dry contact 1 status.			
Function status	Dry contact 2 status	1 bit	C R T
This object, is used to set the dry contact 2 status.			

4.3. LUX THRESHOLD

At the following table, the objects associated with the lux threshold are described.

Object Name	Function	Type	Flags
Output input A	Lux threshold A lower(0~15K)	2 Byte	C R W T U
This object, is used to set the lux threshold A lower value(0~15K).			
Output input A	Lux threshold A upper(0~15K)	2 Byte	C R W T U
This object, is used to set the lux threshold A upper value(0~15K).			
Output input A	Lux threshold A independent	1 bit	C R W T U
This object, is used to set the Lux threshold A independent value.			
Output input A	Lux threshold B independent	1 bit	C R W T U
This object, is used to set the Lux threshold B independent value.			
Output input A	Lux threshold C independent	1 bit	C R W T U
This object, is used to set the Lux threshold C independent value.			

4.4. TEMPERATURE THRESHOLD

At the following table, the objects associated with the temperature threshold are described.

Object Name	Function	Type	Flags
Object input A	Temperature threshold lower	2 Byte	C R W T
This object, is used to set the temperature threshold lower value.			
Object input A	Temperature threshold upper	2 Byte	C R W T
This object, is used to set the temperature threshold upper value.			

4.5. HUMIDITY THRESHOLD

At the following table, the objects associated with the humidity threshold are described.

Object Name	Function	Type	Flags
Object input A	Humidity threshold lower	2 Byte	C R W T
This object, is used to set the humidity threshold lower value.			
Object input A	Humidity threshold upper	2 Byte	C R W T
This object, is used to set the humidity threshold upper value.			

4.6. EXTERNAL TELEGRAM

At the following table, the objects associated with the external telegram are described.

Object Name	Function	Type	Flags
Output input A	External telegram 1 (1 bit)	1 bit	C W U
This object, is used to set the 'external telegram 1' with 1 bit value.			
Output input A	External telegram 1 (1 byte)	1 Byte	C W U
This object, is used to set the 'external telegram 1' with 1 byte value.			
Output input A	External telegram 1 (2 bytes)	2 Bytes	C W U
This object, is used to set the 'external telegram 1' with 2 byte value.			
Output input A	External telegram 1 (float)	float	C W U
This object, is used to set the 'external telegram 1' with float value.			
Output input A	External telegram 1 (4 bytes)	4 bytes	C W U
This object, is used to set the 'external telegram 1' with 4 byte value.			
Output input A	External telegram 2 (1 bit)	1 bit	C W U
This object, is used to set the 'external telegram 2' with 1 bit value.			
Output input A	External telegram 2 (1 byte)	1 Byte	C W U
This object, is used to set the 'external telegram 2' with 1 byte value.			
Output input A	External telegram 2 (2 bytes)	2 Bytes	C W U
This object, is used to set the 'external telegram 2' with 2 byte value.			
Output input A	External telegram 2 (float)	float	C W U
This object, is used to set the 'external telegram 2' with float value.			
Output input A	External telegram 2 (4 bytes)	4 bytes	C W U
This object, is used to set the 'external telegram 2' with 4 byte value.			

4.7. OBJECT OUTPUT

At the following table, the objects associated with the object output are described.

Object Name	Function	Type	Flags
Object output A1	Switching	1 bit	C R T
This object, is used to set the object output with switching function via the related group address.			
Object output A2	Absolute Dimming	1 Byte	C R T
This object, is used to set the object output with dimming function via the related group address.			

Object output A3	Shutter	1 bit	C R T
This object, is used to set the object output with shutter function via the related group address.			
Object output A4	Alarm	1 bit	C R T
This object, is used to set the object output with alarm function via the related group address.			
Object output A5	Percentage	1 byte	C R T
This object, is used to set the object output with percentage function via the related group address.			
Object output A6	Sequence	1 bit	C R T
This object, is used to set the object output with sequence function via the related group address.			
Object output A7	Scene	1 Byte	C R T
This object, is used to set the object output with scene function via the related group address.			
Object output A8	String(14 byte)	14 byte	C R T
This object, is used to set the object output with string function via the related group address.			
Object output A9	Threshold (0...65535)	2 byte	C R T
This object, is used to set the object output with threshold(2 byte) function via the related group address.			
Object output A10	Threshold (0...255)	1 byte	C R T
This object, is used to set the object output with threshold(1 byte) function via the related group address.			

4.8. OBJECT INPUT

At the following table, the objects associated with the object input are described.

Object Name	Function	Type	Flags
Object input A1	Switching delay time on TRUE	2 Byte	C W R T
This object, is used to change delay time via bus with switching delay time on True function.			
Object input A1	Switching delay time on FALSE	2 Byte	C W R T
This object, is used to change delay time via bus with switching delay time on False function.			
Object input A2	Dimming delay time on TRUE	2 Byte	C W R T
This object, is used to change delay time via bus with dimming delay time on True function.			
Object input A2	Dimming delay time on FALSE	2 Byte	C W R T
This object, is used to change delay time via bus with dimming delay time on False function.			
Object input A3	Shutter delay time on TRUE	2 Byte	C W R T
This object, is used to change delay time via bus with shutter delay time on True function.			

Object input A3	Shutter delay time on FALSE	2 Byte	C W R T
This object, is used to change delay time via bus with shutter delay time on False function.			
Object input A4	Alarm delay time on TRUE	2 Byte	C W R T
This object, is used to change delay time via bus with alarm delay time on True function.			
Object input A4	Alarm delay time on FALSE	2 Byte	C W R T
This object, is used to change delay time via bus with shutter delay time on False function.			
Object input A5	Percentage delay time on TRUE	2 byte	C W R T
This object, is used to change delay time via bus with percentage delay time on True function.			
Object input A5	Percentage delay time on FALSE	2 Byte	C W R T
This object, is used to change delay time via bus with percentage delay time on False function.			
Object input A6	Sequence delay time on TRUE	2 Byte	C W R T
This object, is used to change delay time via bus with sequence delay time on True function.			
Object input A6	Sequence delay time on FALSE	2 Byte	C W R T
This object, is used to change delay time via bus with sequence delay time on False function.			
Object input A7	Scene delay time on TRUE	2 Byte	C W R T
This object, is used to change delay time via bus with scene delay time on True function.			
Object input A7	Scene delay time on FALSE	2 Byte	C W R T
This object, is used to change delay time via bus with scene delay time on False function.			
Object input A8	String delay time on TRUE	2 Byte	C W R T
This object, is used to change delay time via bus with string delay time on True function.			
Object input A8	String delay time on FALSE	2 Byte	C W R T
This object, is used to change delay time via bus with string delay time on False function.			
Object input A9	Threshold delay time on TRUE	2 Byte	C W R T
This object, is used to change delay time via bus with threshold delay time on True function.			
Object input A9	Threshold delay time on FALSE	2 Byte	C W R T
This object, is used to change delay time via bus with threshold delay time on False function.			

4.9. LOGIC A

At the following table, the objects associated with the logic A are described.

Object Name	Function	Type	Flags
Logic A status	'1'-True/'0'-False	1 bit	C R T
This object, is used to set the Logic A status.			
<1> Logic A function	Disable/Enable logic function	1 bit	C W R T
This object, is used to set the <1> Logic A function in order to enabling or disabling.			
<2> Logic A function	Disable/Enable logic function	1 bit	C W R T
This object, is used to set the <2> Logic A function in order to enabling or disabling.			
Logic A function	Disable/Enable status function	1 bit	C W R T
This object, is used to enable or disable the status function.			

4.10. EXTEND CONTACT

At the following table, the objects associated with the extend contact are described.

Object Name	Function	Type	Flags
Extend contact 1	Switching	1 bit	C R W T
This object, is used for switching operation via 1 bit value.			
Extend contact 1	Dimming	4 bit	C R W T
This object, is used for dimming operation via 4 bit value.			
Extend contact 1	Call scene	1 byte	C R W T
This object, is used to call scene operation via 1 byte value.			
Extend contact 1	Percentage	1 byte	C R W T
This object, is used for percentage operation via 1 byte value.			
Extend contact 1 short	Switching(Toggle)	1 bit	C R W T
This object is used for toggle operation with 1 bit value and short press.			
Extend contact 1 short	Switching(ON)	1 bit	C R W T
This object is used for switching(ON) operation with 1 bit value and short press.			
Extend contact 1 short	Switching(OFF)	1 bit	C R W T
This object is used for switching(OFF) operation with 1 bit value and short press.			
Extend contact 1 short/long scene save	Call scene	1 byte	C R W T
This object is used for call scene operation with 1 byte value and short/long press.			

Extend dry contact 1 short/long	Percentage	1 byte	C R W T
This object is used for percentage operation with 1 byte value and short/long press.			
Extend dry contact 1	LED status	1 bit	C R W T
This object, is used to set the LED status via 1 bit value.			
Extend contact 1 long	Switching(Toggle)	1 bit	C R W T
This object is used for toggle operation with 1 bit value and long press.			
Extend contact 1 long	Switching(ON)	1 bit	C R W T
This object is used for switching(ON) operation with 1 bit value and long press.			
Extend contact 1 long	Switching(OFF)	1 bit	C R W T
This object is used for switching(OFF) operation with 1 bit value and long press.			
Extend contact 1 long	Dimming	4 bit	C R W T
This object is used for dimming operation with 4 bit value and long press.			
Extend contact 1 long	Scene dimming	4 bit	C R W T
This object is used for scene dimming operation with 4 bit value and long press.			

4.11. CONSTANT BRIGHTNESS A

At the following table, the objects associated with the constant brightness are described.

Object Name	Function	Type	Flags
Constant brightness A	'1'-Start/'0'-Stop '0'-Start/'1'-Stop	1 bit	C W T U
This object, is used to set the constant brightness A with start/stop operation via 1 bit value.			
Constant brightness A	Dimming output value (0...100%)	1 byte	C R T
This object, is used to set the constant brightness A with dimming operation via 1 byte value.			
Constant brightness A	External Lux telegram (0~15K)	2 byte	C R W T
This object, is used to set the constant brightness A with external lux telegram via 2 byte value.			
Constant brightness A	Constant bri. Lux(0~15K)	2 byte	C R W T
This object, is used to set the constant brightness A with constant bri. Lux via 2 byte value.			

4.12. FORCED OPERATION

At the following table, the objects associated with the forced operation are described.

Object Name	Function	Type	Flags
Forced operation A1	'1'-Start/'0'-Stop '0'-Start/'1'-Stop '1/0'-Start '0/1'-Stop	1 bit	C W T

This object, is used to set the forced operation A1 via 1 bit value.

Forced operation A2	'1'-Start/'0'-Stop '0'-Start/'1'-Stop '1/0'-Start '0/1'-Stop	1 bit	C W T
---------------------	---	-------	-------

This object, is used to set the forced operation A2 via 1 bit value.

Forced operation A3	'1'-Start/'0'-Stop '0'-Start/'1'-Stop '1/0'-Start '0/1'-Stop	1 bit	C W T
---------------------	---	-------	-------

This object, is used to set the forced operation A3 via 1 bit value.

Forced operation A4	'1'-Start/'0'-Stop '0'-Start/'1'-Stop '1/0'-Start '0/1'-Stop	1 bit	C W T
---------------------	---	-------	-------

This object, is used to set the forced operation A4 via 1 bit value.

4.13. FORCED OPERATION DIMMING

At the following table, the objects associated with the forced operation dimming are described.

Object Name	Function	Type	Flags
Forced operation dimming A1	Change dimming value (0...100%)	1 byte	C R W T U

This object, is used for changing dimming value via 1 byte value.

Forced operation dimming A2	Change dimming value (0...100%)	1 byte	C R W T U
-----------------------------	------------------------------------	--------	-----------

This object, is used for changing dimming value via 1 byte value.

Forced operation dimming A3	Change dimming value (0...100%)	1 byte	C R W T U
--------------------------------	------------------------------------	--------	-----------

This object, is used for changing dimming value via 1 byte value.

Forced operation dimming A4	Change dimming value (0...100%)	1 byte	C R W T U
--------------------------------	------------------------------------	--------	-----------

This object, is used for changing dimming value via 1 byte value.

4.14. CONSTANT BRIGHTNESS A TRIGGER

At the following table, the objects associated with the constant brightness a trigger are described.

Object Name	Function	Type	Flags
Constant brightness A Trigger 1	'1/0'-trigger	1 bit	C R W T

This object, is used for constant brightness A 1 trigger. If '1/0' value is sent, it will trigger.

Constant brightness A Trigger 2	'1/0'-trigger	1 bit	C R W T
------------------------------------	---------------	-------	---------

This object, is used for constant brightness A 2 trigger. If '1/0' value is sent, it will trigger.

Constant brightness A Trigger 3	'1/0'-trigger	1 bit	C R W T
------------------------------------	---------------	-------	---------

This object, is used for constant brightness A 3 trigger. If '1/0' value is sent, it will trigger.

CONTACT INFORMATION

THE INTERRA WEB SITE

Interra provides documentation support via our WWW site www.interra.com.tr. This web site is used as a means to make files and information easily available to customers. Accessible by using your favorite Internet browser, the web site contains the following information:

- Information about our products and projects.
- Overview of Interra company and values.
- Product Support: Data sheets, product manuals, application descriptions, latest software releases, ETS databases and archived software.

Europe, Turkey

WALL MOUNT OUTDOOR MICROWAVE SENSOR - Product Manual

Interra

Cumhuriyet mh. Kartal cd. No:95/1

Simkan Plaza 34876 Kartal/İstanbul

Tel: +90 (216) 326 26 40 Fax: +90 (216) 324 25 03

Web address: <http://www.interra.com.tr/>